

PATIENT/CAREGIVER INSTRUCTIONS

Oxygen Cylinder and Concentrator Systems



APRIA HEALTHCARE®

Follow all warnings and instruction labels on
medical devices.

To obtain a copy of the manufacturer's product manual,
visit us at **apria.com**

Table of Contents

Oxygen.....	1
Oxygen Safety Precautions	2
Handwashing Technique	4
Care of Your Oxygen Tubing	4
Physical Problems	5

OXYGEN CYLINDER

Your Oxygen Cylinder System.....	6
Pediatric Applications.....	6
Your Stationary Cylinder System	7
Your Portable Cylinder System	9
Oxygen Cylinder Supply Times.....	11
Replacing Your Cylinder.....	12
Reordering Oxygen.....	14
Oxygen Cylinder Troubleshooting.....	15

OXYGEN CONCENTRATOR

Your Oxygen Concentrator.....	16
Operating Your Oxygen Concentrator ...	16
Cleaning and Maintenance Procedures...	18
Care of Your Humidifier Bottle.....	19
Oxygen Concentrator Troubleshooting ...	20
Travel Tips	21
Feedback on Our Services	22

Oxygen

Oxygen is a prescribed drug. **Never increase or decrease your oxygen flow rate without the specific approval of your physician.**

If your physician changes your oxygen

flow rate or hours of use, notify Apria Healthcare immediately.

All people need oxygen in order to live. Oxygen is a gas that we can't see, taste, or smell, yet is always there in the air which surrounds us.

The amount of oxygen in the air is always 21%.

Oxygen is inhaled into our lungs and is then transported through the blood to all parts of the body. Oxygen helps convert food to heat and energy. This process is called metabolism. When the respiratory system is working properly, oxygen is inhaled and transported to the cells with ease. Carbon dioxide, a by-product of metabolism, is then returned to the lungs and exhaled.

Using Supplemental Oxygen

The 21% concentration of oxygen in the air around us is enough for people with normally functioning lungs and heart. However, a person with lung or heart problems may often benefit from breathing air which has a higher concentration of oxygen in it.

When the body does not get enough oxygen, a person may experience difficulty in breathing, fatigue, loss of memory, headaches and/or confusion. Using supplemental oxygen may help provide relief from these symptoms.

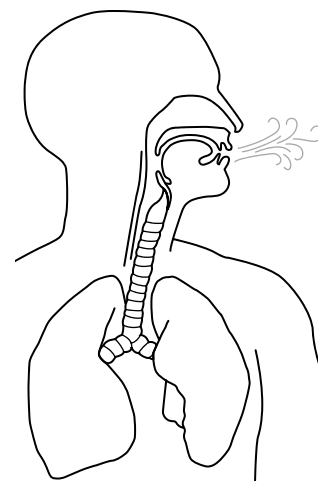

The respiratory system

Oxygen Safety Precautions

Oxygen can be used safely when handled and stored properly.

By using the following safety guidelines, you will create a very safe environment when you use your oxygen.

Warning: ⚠️ Cylinders contain oxygen which is under high pressure. The oxidizing gas vigorously accelerates combustion (a fire) if the oxygen inside the cylinder is near fire or open flames. (See “Warning: Heat” below.)

For safety reasons, it is recommended that you install smoke alarms outside each sleeping area and on each level in the home. Fire extinguishers are also recommended.

Warning: ⚠️ Heat

Keep oxygen equipment and oxygen tubing at least five (5) feet away from any source of heat.

Keep the oxygen equipment and oxygen tubing away from open flames, stoves, space heaters, or any source of heat.

Cylinders under high pressure may be explosive if exposed to extreme heat.

Warning: ⚠️ Grease/Flammables

Never use grease or oil on oxygen equipment.

Keep oxygen equipment away from all flammable materials such as oil, grease,

aerosols, paints, gasoline and solvents. Hand, hair or body lotions should not come in contact with oxygen equipment.

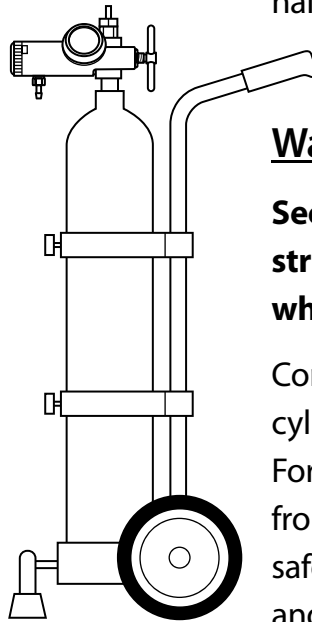

Warning: ⚠️ Cylinder Stability

Secure cylinders against falling or striking other objects at all times, even when traveling.

Compressed gas oxygen is stored in cylinders under very high pressures. For this reason, cylinders must be secured from falling or rolling at all times. For safety purposes, a cylinder should be used and transported in a specifically designed

cylinder cart and/or carrying case. For information on securing cylinders for storage, see the “Storage” section on page 3.

The weight of the cylinder may cause injury and damage property if it were to fall on someone or something. The cylinder valve could also be knocked off if the cylinder were to fall over. The high pressure coming out of a broken valve opening could then cause the cylinder to move about the room in a destructive, uncontrolled manner. If this happens, move away from the cylinder and call Apria Healthcare immediately. Please ventilate the room.

No Smoking

Do not permit smoking in the same room as your oxygen equipment. This includes electronic cigarettes (e-cigarettes).



Place **“No Smoking”** signs on the front door or in a front window of your residence. Apria also encourages you to post “No Smoking” signs in the room where your equipment is in use.

It is possible for you to be in a large room such as a restaurant where smoking is permitted as long as lighted smoking materials are not within five (5) feet of you. Nevertheless, when visiting restaurants, always ask to sit in the no smoking section.

Cooking

It is best to cook using a microwave oven only. Cooking on a gas or electric stove is not recommended.

Storage

Do not place your oxygen equipment in a small or unventilated storage area.

Do not place oxygen equipment in a small storage area such as a closet or car trunk. Any venting oxygen could create a fire hazard.

At Home

Cylinders may be stored either lying down (unstacked) or upright in a specially designed oxygen cylinder base or cart. When storing portable oxygen cylinders, the cylinders must be secured at all times from falling, if upright, or from rolling, if lying down. It is possible to store cylinders under a bed, if the area is well ventilated and the bedding does not extend to the floor.

While Traveling

When traveling with oxygen cylinders, the

cylinders must be secured from movement at all times. Cylinders may be stored either lying down (unstacked) or upright in an approved oxygen cylinder storage rack.

Please store and care for your oxygen cylinders and concentrator carefully. Do not store oxygen equipment in an unattended vehicle.

Oil-Based Toiletries and Small Appliances

When using oxygen, never use oil-based face or hair creams, a hair dryer or an electric razor.

It is possible in certain conditions that the combination of oxygen, oil-based toiletries, and a spark from an electrical appliance such as an electric blanket, hair dryer, electric razor or heating pad, could ignite and cause burns. Never use oil-based hair lubricants, face and hand lotions, petroleum jelly products, or aerosol sprays. Always use water-based cosmetics or creams.

Furniture Polish

Clean the concentrator surface with a damp cloth. **Never use wax, spray or furniture polish to clean any type of oxygen equipment.**

Extension Cord

Do not use an extension cord with the concentrator.

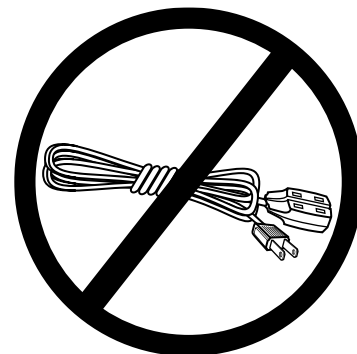

Electrical Outlet

Never plug the concentrator into an outlet that is being used to power other major appliances.

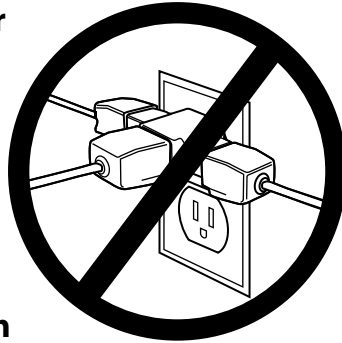

Home Address

Make sure your home address can be easily seen from the street during both day and night.

Check to see that your address numbers are easy to spot and read from the street. If you are expecting a night delivery or visit, turn on the porch light. This will allow all Apria Healthcare and emergency personnel to locate your residence easily.

Emergencies and Natural Disasters

In the event of an emergency or natural disaster, follow the internet, radio or television emergency instructions broadcast by your local authorities.

Handwashing Technique

Thorough handwashing must be done prior to all procedures. Contaminated, dirty hands are one of the most common sources of infection.

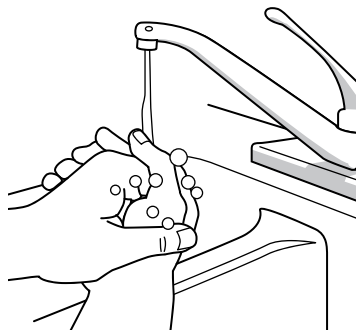

Wash hands for 20 seconds

1. Wet your hands thoroughly with warm water.

2. Use soap.
3. Scrub hands for 20 seconds using a rotary motion and friction. Wash:
 - Back and palm of each hand
 - Between all fingers
 - FingernailsNeed a timer? Hum the "Happy Birthday" song from beginning to end twice.
4. Rinse your hands under the running water.
5. Dry on clean towel or with a paper towel.

For additional good health habits, visit our Patient Education section on apria.com.

Care of Your Oxygen Tubing

Minimal care is required of your oxygen tubing and nasal cannula

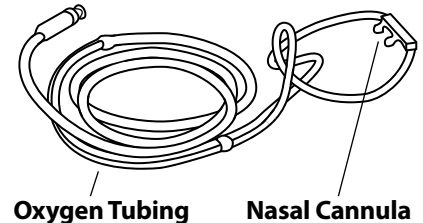

or oxygen mask. We recommend that once or twice during the day, you remove the cannula or mask and wipe it clean with a damp cloth. You should discard and replace your nasal cannula or oxygen mask once a month. **Discard and replace your tubing once every 6 months.**

Warning: ⚠ Do not use alcohol or oil-based products on or near your cannula or mask.

Concentrator System

Moisture may accumulate inside the oxygen tubing, especially if you are using

a humidifier bottle. Excess moisture may reduce oxygen flow. If this happens you should try the following steps:

You should use your back-up/portable oxygen system while refilling and cleaning your humidifier bottle.

Step 1: Remove the humidifier bottle from the concentrator.

Step 2: Attach a nipple adapter to backup cylinder.

Step 3: Remove the oxygen tubing from the humidifier bottle and attach it to the nipple adapter on your backup tank.

Step 4: Open the flow on your oxygen backup tank, and allow the oxygen to run directly through the tubing. Within a few minutes, the tubing will be dry.

Step 5: When the tubing is dry, disconnect it from backup tank. Reconnect the humidifier bottle to the concentrator and reattach the oxygen tubing to the humidifier bottle.

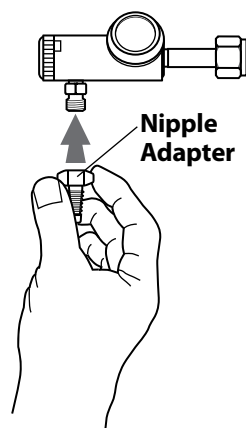

Attach nipple adapter to outlet of oxygen regulator

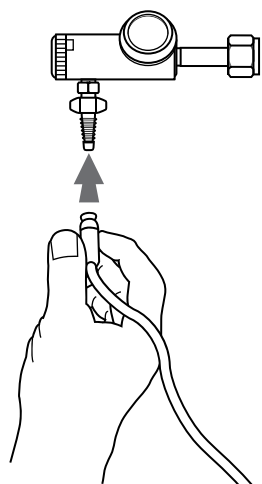

Attach oxygen tubing to nipple adapter

Step 6: Check the liter flow to make sure the oxygen is flowing at the prescribed level.

Note: If excess moisture is a recurrent problem, be sure to call your Apria location to request a “water trap.”

Physical Problems

If you experience any of the following problems, call your physician:

- Increased shortness of breath
- Chest pain
- Fever or chills
- Increased wheezing
- Increased mucus production
- Mucus becomes thicker
- Change in mucus color
- Headaches
- Loss of appetite
- Increased cough
- Swelling in your ankles or around your eyes
- Weight gain overnight
- Feeling dizzy or sleepy
- Any change in physical sensation after taking a new medication

If you experience **severe physical problems**, call 911 or your local emergency services.

If you experience any **physical change**, call your physician.

If you are having trouble with your **equipment**, call Apria Healthcare.

Your Oxygen Cylinder System

With this system, oxygen gas is pressurized to a high level and stored in steel or aluminum cylinders. The pressure is measured in pounds per square inch (PSI). The higher the pressure, the greater the amount of oxygen which can be compressed into the space of the cylinder.

Your **cylinder system** consists of the following parts: the **cylinder** which stores the pressurized oxygen, the **cylinder stand** which stabilizes the cylinder to prevent accidental tipping, a **regulator** which controls the flow of oxygen from the cylinder and, if recommended, a **humidifier bottle**.

The oxygen is delivered to you through a nasal cannula or face mask. The tubing on the cannula or mask is attached to the outlet on the regulator. Sometimes, an extra length of tubing may be provided. This will allow you to move about at a farther distance from your cylinder.

Oxygen cylinders are available in various sizes. Depending upon the size of the cylinder and the amount of oxygen you use, the oxygen will last for different periods of time.

The most commonly used large cylinder is the M cylinder. This cylinder weighs approximately 50 pounds and is meant to be used as a stationary source. It contains over 3450 liters

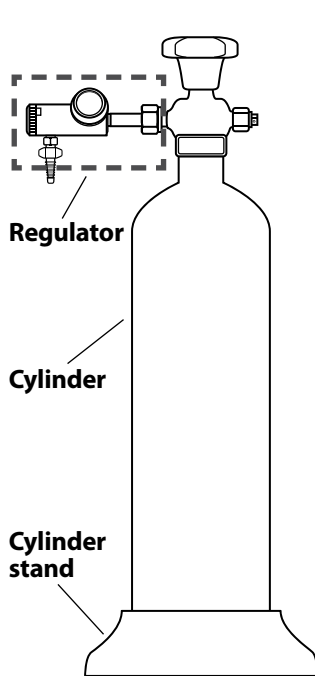

M cylinder system

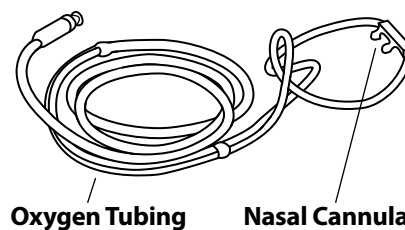

of oxygen. At 2 liters per minute, this is enough oxygen for over 24 hours of continuous use.

Patients needing a portable supply of oxygen use a smaller lightweight system. The weight of these portable cylinders ranges from 3.5 to 18 pounds.

There are several sizes of portable oxygen cylinders. The most common are the M6 (B), ML6, and E cylinders.

The M6 or B cylinder is the smallest of these cylinders. It is made of aluminum and is almost always used with an oxygen conserving device. When used in conjunction with an oxygen conserving device, the M6 cylinder at a setting of 2 will last approximately 4 hours. The M6 cylinder is usually carried in a carrying case with a shoulder strap. The E cylinder is the largest of the portables and is often used with a wheeled cart.

Pediatric Applications

If the prescribed flow rate of oxygen is less than one liter per minute, a special pediatric regulator is used. The pediatric regulator has settings for very low flows, such as 1/16, 1/8 and 1/4.

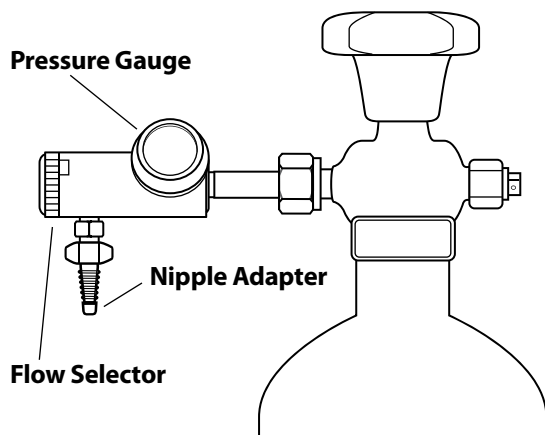

Regulator on a stationary oxygen cylinder

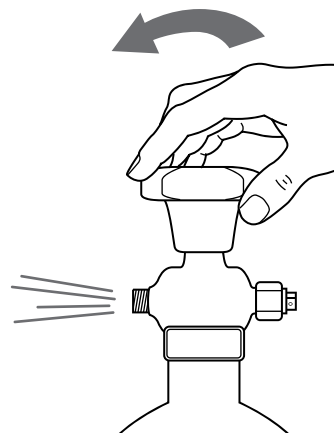

Clear dust from connector orifice (Step 2)

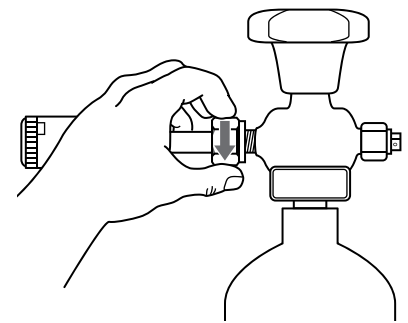

Attach regulator to cylinder (Step 3)

Your Stationary Cylinder System

The regulator on a stationary cylinder system consists of the **pressure gauge** which tells you how much oxygen is left in the tank and a **flow selector** which indicates the flow rate of oxygen.

Operating Your Large Stationary Cylinder System

The following step-by-step instructions will help you operate your cylinder system.

Attaching the Regulator to a Full Cylinder

To attach the regulator assembly to a full cylinder, follow the steps below.

Caution: Make sure the valve opening is not directed at yourself or anyone else when opening the cylinder.

Step 1: Remove the dust cover from the cylinder outlet.

Step 2: Open the cylinder valve slightly by turning counterclockwise. This will blow off any dust in the orifice of the cylinder outlet. Close the valve tightly.

Step 3: Attach the regulator to the cylinder by threading the regulator connector nut clockwise on the cylinder outlet. Tighten firmly with a cylinder wrench.

Step 4: If not already present, attach a nipple adapter to the regulator outlet and attach the oxygen tubing to the nipple adapter.

Turning On Your Oxygen

Step 1: **Slowly** open the cylinder valve by turning counterclockwise. (Never open the cylinder quickly as this may damage the regulator and/or cause heat buildup in the regulator.) The needle in the

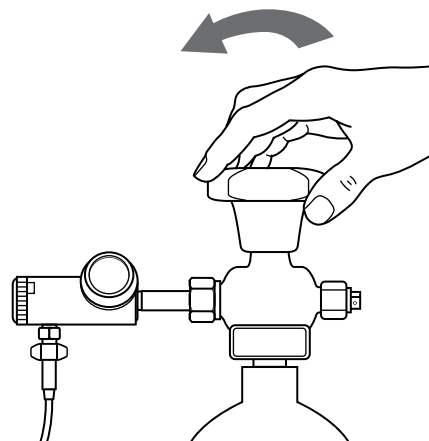

Turn counterclockwise to open cylinder valve

pressure gauge will register the amount of oxygen in the cylinder. A full cylinder registers approximately 2,000 pounds per square inch (PSI).

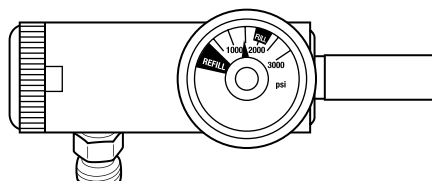

Pressure gauge on regulator

Step 2: Adjust the flow selector knob until the number in the window is your prescribed flow rate number.

Warning: ⚠️ Your physician has prescribed the oxygen flow rate for you. **Never change the flow rate without instructions from your physician.** If you are confused about the prescribed setting, please consult your physician or Apria Healthcare immediately.

Step 3: Fit the nasal cannula or the oxygen mask to your face so that it is comfortable. Follow the instructions below for either the nasal cannula or the oxygen mask, depending on what your physician has directed you to use.

Nasal Cannula

- Insert the two prongs of the cannula into your nostrils. Make sure the prongs face upward and curve into your nostrils.
- Slide the tubing over and behind each ear.



Adjust nasal cannula



Adjust oxygen mask

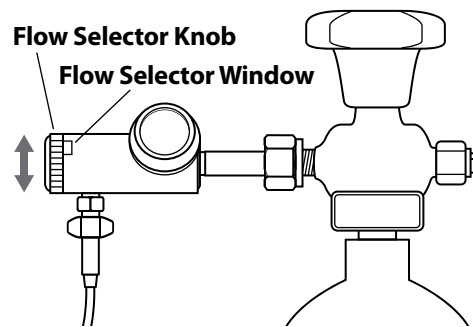

Turn flow selector knob to adjust oxygen flow (Step 2)

- Adjust the tubing to fit comfortably under your chin by sliding the adjuster upward. Be careful not to adjust it too tightly.

Oxygen Mask

- Place the oxygen mask over your mouth and nose.
- Slide the loose elastic strap over your head and position it above your ears.
- Pull the end of the elastic on each side of the mask until the mask fits comfortably.
- Pinch the metal nose strap to fit snugly around your nose. This will prevent oxygen from blowing into your eyes.

Note: Do not use an oxygen mask if your physician prescribed a nasal cannula.

Oxygen masks must only be used with liter flow rates of five liters (or more) per minute.

Always use your oxygen at the proper flow rate for the number of hours each day your physician has prescribed. Contact Apria Healthcare if your contents pressure is 500 psi or lower (in the red zone).

Turning Off Your Oxygen

When you are finished using your oxygen cylinder, turn off your cylinder system by following these steps:

Step 1: Remove the nasal cannula or oxygen mask.

Step 2: Turn the cylinder valve clockwise until snug. (Do not overtighten.)

- This stops the flow of oxygen from the cylinder.
- The needle on the pressure gauge will drop to zero.

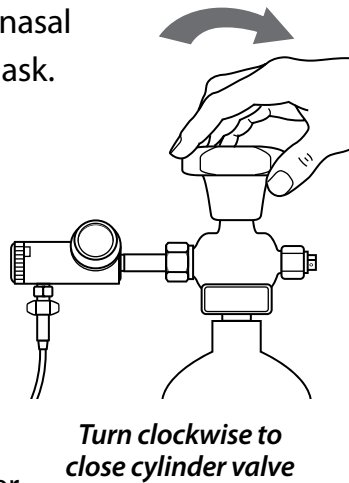

Step 3: When the pressure gauge registers zero, turn the flow selector knob counterclockwise so that the “0” position is visible in the flow selector window.

Your Portable Cylinder System

Your **portable cylinder system** consists of a **cylinder**, which stores the pressurized oxygen, and a **regulator**, which controls the flow of oxygen from the cylinder. In addition, there is a **special washer** that fits between the regulator and the cylinder which prevents the oxygen from leaking out of the cylinder when the regulator is attached.

Caution: It is very important that the proper washer be used at all times. Only use the washer provided. If you have lost or cannot find the washer, contact Apria Healthcare immediately for a replacement.

DO NOT use the cylinder and regulator without the washer.

Most smaller portable cylinders are used with a carrying case. The larger portable cylinder may be used with a wheeled cart.

The regulator consists of the **pressure gauge**, which tells you how much oxygen is left in the cylinder, and a **flow selector**, which indicates the flow rate of oxygen.

Note: Do not use a humidifier bottle with a portable system.

Operating Your Portable Cylinder System

The following step-by-step instructions will help you operate your portable cylinder system.

Attaching the Regulator to a Full Cylinder

To attach the regulator, follow these steps:

Step 1: Wash hands. (See page 4.)

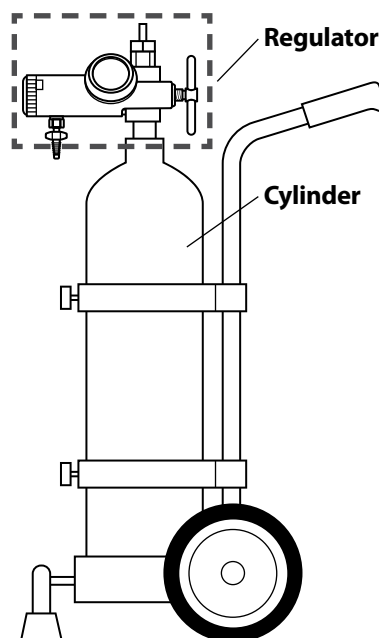

Portable cylinder with cart

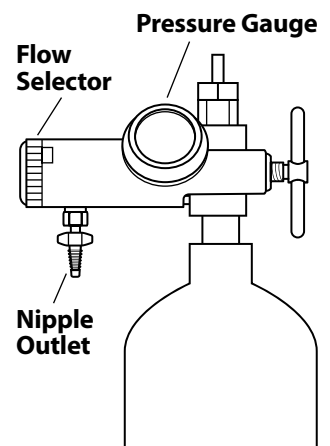

Regulator on a portable oxygen cylinder

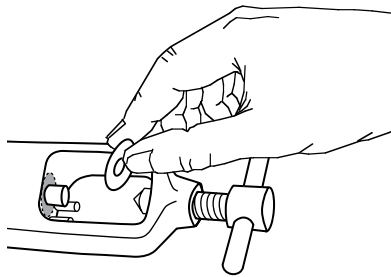

*Replace the washer, if needed
(Step 5)*

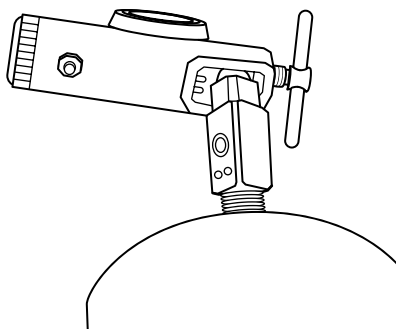

Install the regulator (Step 6)

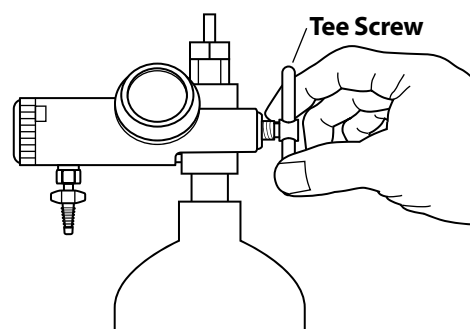

Hand tighten the tee screw (Step 7)

Caution: Make sure the valve opening is not directed at yourself or anyone else when opening the cylinder.

Step 2: Slowly remove any protective tape. Using only the cylinder wrench provided, open the cylinder valve slightly by turning counterclockwise. This will blow off any dust in the orifice of the cylinder outlet. Close the valve tightly.

Step 3: Make sure valve system is free of all debris and oil.

Step 4: Inspect the regulator and make sure that the washer is in place before attempting to place the regulator on the cylinder. **If the washer is missing or is deformed, damaged, or broken, it needs to be replaced before the cylinder and regulator can be used. Call Apria Healthcare immediately for a replacement. DO NOT use the regulator with a missing or damaged washer.**

Step 5: If the washer needs to be replaced, remove the old washer and replace it with a new one. Do not use any sharp instruments (e.g., knife) to remove the old washer; sharp instruments

could scratch the regulator and cause an oxygen leak.

Step 6: Slip the regulator over the cylinder valve and neck of the full cylinder. Line up the pins on the regulator with the holes on the neck of the cylinder.

Step 7: Hand tighten the tee screw by turning clockwise.

Step 8: Slowly open the cylinder valve by turning the nut at the top of the valve counterclockwise. Never open the valve rapidly. Your system may require the use of a cylinder wrench. If there is a leak you may hear a hissing sound. Tighten the tee screw to secure the connection. If the leak persists, the washer may be damaged and may need to be replaced. Call Apria Healthcare if you need a

replacement washer. Then see Step 5 for replacing the washer.

If the leak persists, call Apria Healthcare.

Step 9: Attach the oxygen tubing to the nipple outlet.

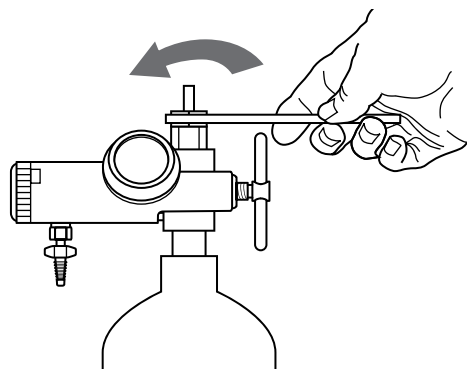

*Turn counterclockwise to open
the cylinder valve (Step 8)*

Turning On Your Oxygen

To turn on your portable cylinder system, follow these steps:

Step 1: **Slowly** open the cylinder valve by turning the nut at the top of the valve counterclockwise. Never open the valve rapidly. You may have to use a cylinder wrench.

The needle on the pressure gauge will register the amount of oxygen in the cylinder. A cylinder shows approximately 2,000 PSI on the gauge.

Step 2: Turn the flow selector knob until the number that is visible in the flow selector window is your prescribed flow rate number.

Your physician has prescribed the oxygen rate for you. **Never change this flow rate without instructions from your physician.**

Step 3: Fit the nasal cannula or oxygen mask to your face so that it is comfortable. See page 8 for more instructions on placement.

Turning Off Your Oxygen

When you are finished using your oxygen, turn off your portable cylinder system using the instructions in the following steps:

Step 1: Remove the nasal cannula or oxygen mask.

Step 2: Close the cylinder valve by turning clockwise until snug. (Do not overtighten.)

Your system may require the use of a cylinder wrench.

- This stops the flow of oxygen from the cylinder.
- The needle on the pressure gauge will drop to zero.

Step 3: When the pressure gauge registers zero, turn the flow selector knob counterclockwise so that the "0" position is visible in the flow selector window.

Oxygen Cylinder Supply Times

Your oxygen flow is measured in liters per minute (LPM).

Average oxygen usage time is based on **continuous** flow rate.

The figures in the charts on pages 12–13 are **approximate** and are to be used only as a **general guide**. Individual usage time will vary.

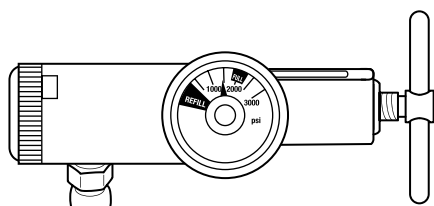

Pressure gauge on regulator

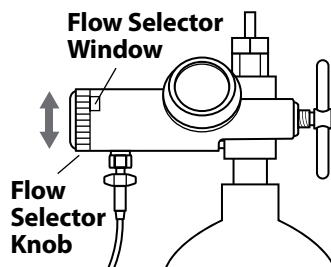

Turn flow selector knob to adjust oxygen flow (Step 2, Turning On Your Oxygen)

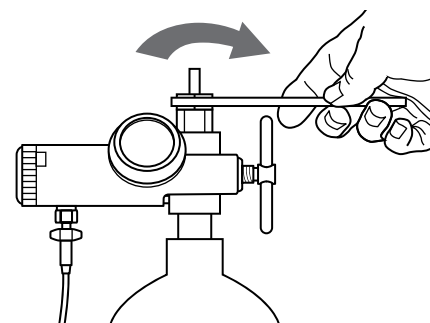

Turn clockwise to close cylinder valve (Step 2, Turning Off Your Oxygen)

Adult Cylinder Supply Time Guide

PRESSURE GAUGE READING	Liter Flow per Minute				
	1	2	3	4	5
	Approximate Time Remaining:				
D Cylinder					
2000 psi	5 hrs.	2 hrs.	1 hr./15 min.	1 hr.	Not recommended
1500 psi	3 hrs./30 min.	1 hr./30 min.	50 min.	45 min.	Not recommended
1000 psi	2 hrs.	1 hr.	30 min.	20 min.	Not recommended
500 psi	1 hr.	15 min.	5 min.	0	Not recommended
E Cylinder					
2000 psi	9 hrs.	4 hrs./30 min.	3 hrs.	2 hrs.	1 hr./30 min.
1500 psi	7 hrs.	3 hrs.	2 hrs.	1 hr./30 min.	1 hr.
1000 psi	4 hrs./30 min.	2 hrs.	1 hr./15 min.	1 hr.	30 min.
500 psi	2 hrs.	1 hr.	25 min.	15 min.	5 min.
M Cylinder					
2200 psi	2 days/9 hrs.	1 day/5 hrs.	19 hrs.	14 hrs.	11 hrs.
1650 psi	1 day/19 hrs.	22 hrs.	14 hrs.	11 hrs.	9 hrs.
1100 psi	1 day/5 hrs.	14 hrs.	10 hrs.	7 hrs.	6 hrs.
550 psi	14 hrs.	7 hrs.	5 hrs.	4 hrs.	3 hrs.
H Cylinder					
2000 psi	4 days/6 hrs.	2 days	1 day/12 hrs.	1 day	19 hrs.
1500 psi	3 days/3 hrs.	1 day/12 hrs.	1 day	17 hrs.	14 hrs.
1000 psi	2 days	1 day	15 hrs.	12 hrs.	9 hrs.
500 psi	1 day	12 hrs.	7 hrs.	6 hrs.	4 hrs.

Replacing Your Cylinder

Step 1: Remove the nasal cannula or oxygen mask.

Step 2: Close the cylinder valve by turning the nut at the top of the tank clockwise until snug. (Do not overtighten.) You may have to use a cylinder wrench.

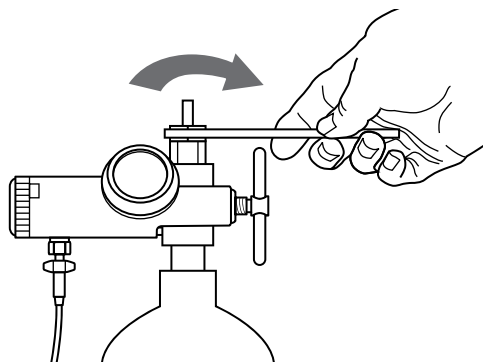

Turn clockwise to close cylinder valve

Step 3: When the pressure gauge registers zero, turn the flow selector knob counterclockwise until it is tight, so that the "0" position is visible in the flow selector window.

Step 4: Loosen the regulator at the tee screw. If necessary, use the key to loosen the screw.

Pediatric Cylinder Supply Time Guide

PRESSURE GAUGE READING	Liter Flow per Minute				
	1/16	1/8	1/4	1/2	3/4
Approximate Time Remaining:					
D Cylinder					
2000 psi	3 days	1 day/12 hrs.	20 hrs.	9 hrs.	6 hrs.
1500 psi	2 days/12 hrs.	1 day/6 hrs.	15 hrs.	7 hrs.	4 hrs.
1000 psi	1 day/12 hrs.	18 hrs.	9 hrs.	4 hrs.	3 hrs.
500 psi	18 hrs.	9 hrs.	4 hrs.	2 hrs.	1 hr.
E Cylinder					
2000 psi	6 days	3 days	1 day	19 hrs.	12 hrs.
1500 psi	4 days	2 days	1 day	14 hrs.	10 hrs.
1000 psi	3 days	1 day	18 hrs.	9 hrs.	6 hrs.
500 psi	1 day	18 hrs.	9 hrs.	5 hrs.	3 hrs.
H Cylinder					
2000 psi	68 days	34 days	17 days	8 days/12 hrs.	5 days/12 hrs.
1500 psi	52 days	26 days	13 days	6 days/12 hrs.	4 days/6 hrs.
1000 psi	34 days	17 days	8 days/12 hrs.	4 days/6 hrs.	2 days/18 hrs.
500 psi	16 days	8 days	4 days	2 days	1 day/9 hrs.

Step 5: Remove the regulator by lifting it up over the cylinder valve.

Step 6: Remove the tank seal from the valve of the new cylinder.

Caution: Make sure the valve opening is not directed at yourself or anyone else when opening the cylinder.

Step 7: Slowly open the cylinder valve slightly by turning counterclockwise. This will blow off any dust in the orifice of the cylinder outlet. Close the valve tightly.

Step 8: Replace the regulator as described on page 7 under "Attaching the Regulator to a Full Cylinder" for standard cylinder systems, or on page 9 under "Attaching the Regulator to a Full Cylinder" for portable cylinder systems.

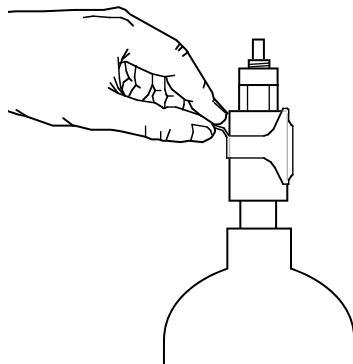

Remove tank seal from valve of new cylinder (Step 6)

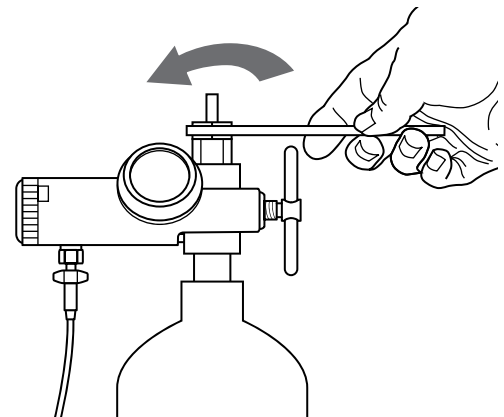

Turn counterclockwise to open the cylinder valve (Step 7)

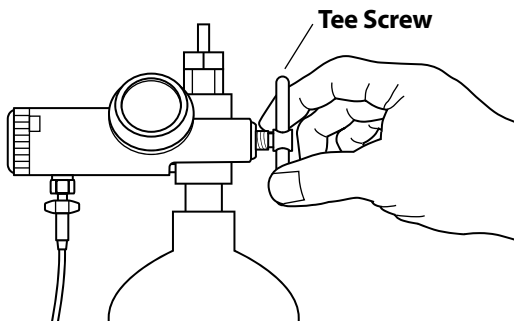

Tighten the tee screw (Step 9)

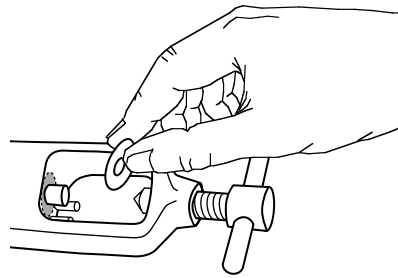

Replace the washer, if needed (Step 10)

Step 9: **Slowly** open the cylinder valve by turning the nut at the top of the valve counterclockwise. Never open the valve rapidly. Your system may require the use of a cylinder wrench. If there is a leak you may hear a hissing sound. Tighten the tee screw to secure the connection. If the leak persists, the washer may be damaged and may need to be replaced.

Step 10: If the washer appears to be deformed, damaged, or broken, it needs to be replaced before the cylinder and regulator can be used. Remove the old washer and replace it with a new one, as shown above. Do not use any sharp instruments (e.g., knife) to remove the old washer; sharp instruments could scratch the regulator and cause an oxygen leak.

If the leak persists, call Apria Healthcare.

Reordering Oxygen

Always be aware of the amount of oxygen remaining in your cylinder.

You will most likely be on an automatic redelivery schedule, but always knowing how much oxygen you have will prevent any worry of running out while your resupply is being delivered.

In order to provide the best possible service to our oxygen customers, Apria has developed the following oxygen resupply process.

- 1) Several days prior to your scheduled delivery day, you will receive an automated call from our scheduling department.
- 2) Listen to the prompts to confirm the need for your resupply order.
- 3) Press “1” to enter the confirmation queue then press “1” to confirm your need for a refill, or “2” to decline your refill order.
- 4) Declined deliveries will automatically be set to the next scheduled delivery day based on your cycle and frequency.

If you are not on an automatic delivery schedule, reorder a new cylinder two days before your cylinder has been calculated to run out. **Please contact your local Apria branch. Branch phone numbers can be found on Apria.com by selecting the FIND A BRANCH option at the top of the web site.** Call this number if you believe you do not have enough cylinders to make it to your next scheduled delivery. This will allow Apria Healthcare to schedule your delivery without causing you to worry.

Consult the tables on pages 12–13 for oxygen cylinder supply time guidelines.

Oxygen Cylinder Troubleshooting

Trouble	Probable Cause	Remedy
No oxygen coming from cannula or mask	Empty cylinder	Check pressure gauge for oxygen contents. If cylinder is empty, remove regulator and attach to new full cylinder. Call Apria Healthcare for additional oxygen.
	Decreased awareness of oxygen flow	Place cannula prongs in a clean glass of water. If you observe bubbles coming from your cannula, your unit is working correctly.
	Faulty cannula or mask	Remove cannula or mask and check tubing for kinks or obstructions. Replace with new cannula or mask if needed.
	Loose connections	Check all connections, especially humidifier bottle to regulator and humidifier top to bottle. Be certain the bottle is screwed on straight. Cross-threading will cause oxygen to escape out the top of the bottle.
	Plugged humidifier bottle	Remove humidifier bottle. If flow is restored, clean or replace with new humidifier bottle.
	Cylinder valve is closed or flow selector is "0"	Check cylinder valve to make sure it is open. Adjust flow selector to prescribed flow rate.
	Faulty regulator	Call Apria Healthcare. NEVER attempt to fix the regulator yourself.
Oxygen cylinder hisses and is leaking oxygen	Regulator not attached tightly	Turn the oxygen off. Check and retighten connection between regulator and cylinder.
	Faulty washer	Replace washer.
	Faulty regulator	Call Apria Healthcare. NEVER attempt to fix the regulator yourself.
All other problems or questions about equipment		Call your Apria Healthcare location.

Your Oxygen Concentrator

An oxygen concentrator is an electrically operated device that draws in room air, separates the oxygen from the other gases in the air and delivers the concentrated oxygen to you. The concentrator acts like a strainer. It traps oxygen and releases the other gases (mostly nitrogen) back into the room air. This process goes on continuously until the oxygen inside the unit is highly concentrated. At two liters per minute, the air which you receive from your concentrator is more than 90 percent oxygen.

Oxygen concentrators are available in different sizes and models. However, all models have the same basic parts: a **power switch** to turn the unit on and off, a **flow selector** that regulates the amount of oxygen you receive and an **alarm system** that alerts you if the power is interrupted.

The oxygen is delivered to you through a nasal cannula or face mask. The tubing on the cannula or mask is attached to the outlet on the unit. Sometimes, an extra length of tubing may be provided. This will allow you to move a farther distance from your concentrator, but the overall tubing length should not be longer than 50 feet (not including the length of the cannula).

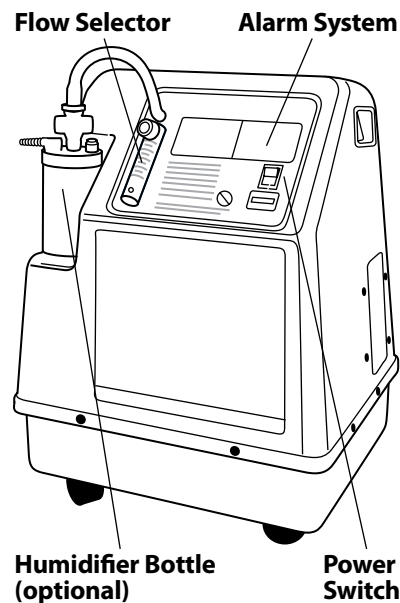

Typical oxygen concentrator

Where to Place Your Concentrator

Place your concentrator in a well-ventilated area, away from fireplaces, the stove, any open flames, any heat source or heat vent. Do not place it in a closet. Place it at least 12 inches from any drapes, bedding, walls or any other item that may block the inlet ports. If the concentrator is too noisy, place it in an adjacent room **but make sure that the alarm is still audible to the patient or caregiver.**

Operating Your Oxygen Concentrator

The following step-by-step instructions will help you operate your oxygen concentrator.

Step 1: Insert the power plug into a nearby power outlet.

Note: Most Apria oxygen concentrators use "2-prong" power plugs and do not require a 3-prong, grounded AC power outlet.

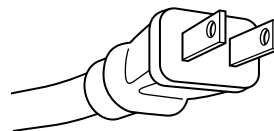

Two-prong power plug

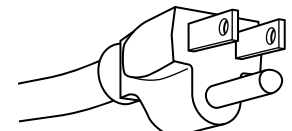

Three-prong (grounded) power plug

However, if the equipment that has been provided to you has a 3-prong power plug and your home does not have 3-prong power outlets, your patient service technician will

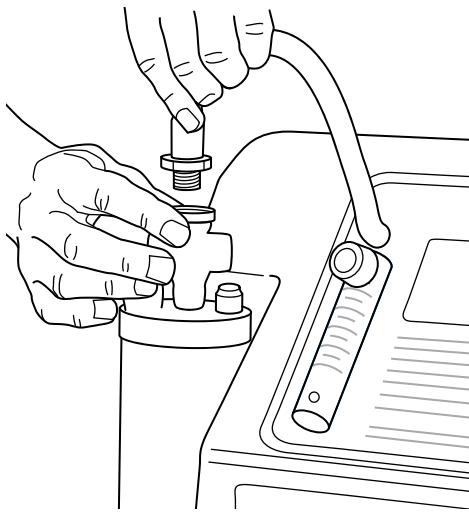

Attach humidifier bottle (Step 3)

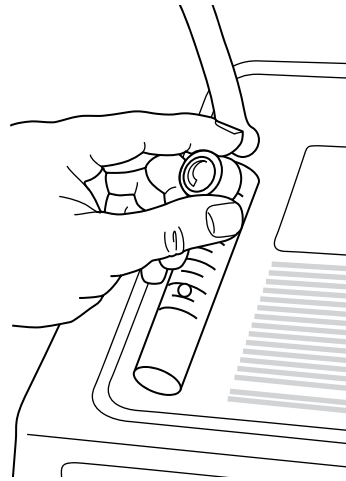

Use flow selector knob to adjust oxygen flow rate (Step 5)

ON position. The alarm will sound for a few seconds until the proper pressure is reached.

Step 5: Adjust the oxygen flow rate by turning the flow selector knob until the middle of the indicator ball is at the prescribed number.

- Your physician has prescribed the oxygen flow rate for you.

exchange your concentrator for a unit that utilizes the 2-prong plug.

Step 2: Attach the oxygen tubing to the nipple outlet on the concentrator.

Step 3: If a humidifier bottle is recommended, attach a filled humidifier bottle.

- Center the threaded cap on the humidifier bottle under the threaded outlet tube on the concentrator.
- Turn the cap on the humidifier bottle until it is tightly screwed onto the outlet tube. Be certain the bottle is screwed on straight. Cross-threading will cause oxygen to escape out the top of the bottle.
- Attach oxygen tubing to the nipple outlet on the humidifier bottle.

Note: Humidifier bottles are generally recommended only for patients using flow rates greater than four liters per minute.

Step 4: Press the ON/OFF switch to the

- Never change this oxygen flow rate without instructions from your physician.

Step 6: Fit the nasal cannula or the oxygen mask to your face so that it is comfortable.

Nasal Cannula:

- Insert the two prongs of the cannula into your nostrils. Make sure the prongs face upward and curve into your nostrils.
- Slide the tubing over and behind each ear.
- Adjust the tubing to fit comfortably under your chin by sliding the adjuster upward. Be careful not to adjust it too tightly.

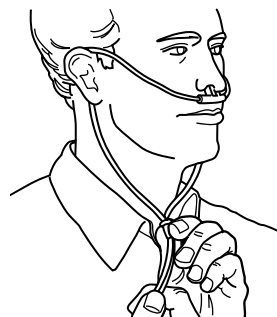

Adjust nasal cannula



Adjust oxygen mask

Oxygen Mask

- Place the oxygen mask over your mouth and nose.
- Slide the loose elastic strap over your head and position it above your ears.
- Pull the end of the elastic on each side of the mask until the mask fits comfortably.
- Pinch the metal nose strap to fit snugly around your nose. This will prevent oxygen from blowing into your eyes.

Note: Do not use an oxygen mask if your physician prescribed a nasal cannula.

Oxygen masks must only be used with liter flow rates of five liters (or more) per minute.

Use your concentrator for the number of hours each day which your physician has prescribed.

Step 7: When you have finished using your oxygen, always:

- Remove the nasal cannula or oxygen mask.
- Turn the ON/OFF switch to the OFF position.

Cleaning and Maintenance Procedures

All Cleaning Must Be Done in a Clean Environment

The external filter, humidifier bottle and cabinet require periodic cleaning. The cabinet can be washed with

a damp cloth. See below for filter maintenance and humidifier bottle care.

Cleaning and decontamination of respiratory therapy equipment in the home is of major concern. To prevent equipment contamination, a simple but effective cleaning procedure must be carried out on a routine basis. Do all cleaning and disinfecting in a clean environment. Avoid doing it after vacuuming, under an open window, or in dusty, dirty, smoky areas.

Filter Cleaning and Maintenance

The external filter requires cleaning once a week.

Step 1: Remove the filter.

Step 2: Wash it in a solution of warm water and a clear liquid detergent.

Step 3: Rinse the filter thoroughly with warm water.

Step 4: Gently squeeze water from the filter, then pat it dry with a clean towel.

Step 5: Once the filter is completely dry, reattach the filter.

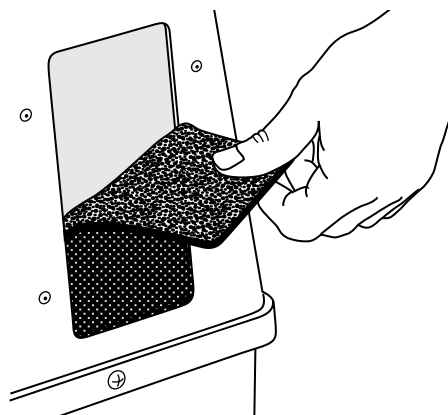

Remove the filter from the concentrator

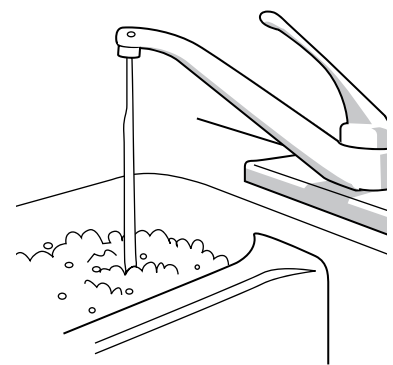

Wash the filter once a week

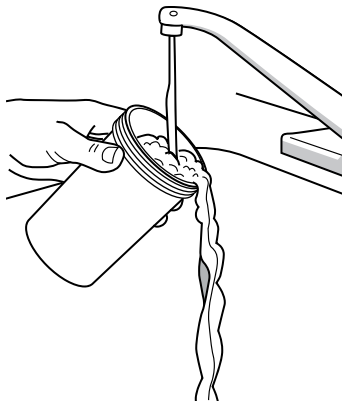

Rinse bottle under a strong stream of warm tap water

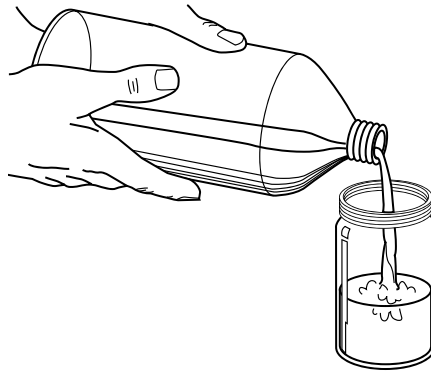

Refill bottle with distilled water to the fill line

Care of Your Humidifier Bottle

If you are using a humidifier bottle with your oxygen concentrator, you will need to check the water level in the bottle frequently. When the water runs low or the bubbling stops, you need to refill the bottle. **Always use your back-up oxygen system while refilling and cleaning your humidifier bottle.**

Refilling the Humidifier Bottle

Step 1: Wash your hands as instructed on page 4.

Step 2: Turn the oxygen concentrator off.

Step 3: Unscrew the bottle from the humidifier bottle lid.

Step 4: Discard any water remaining in the bottle.

Step 5: Rinse bottle under a strong stream of warm tap water. Shake off the excess water.

Step 6: Refill the bottle with distilled water to the fill line. Do not overfill the bottle. Too much water in the bottle will cause water to collect in your oxygen tubing.

Step 7: Screw the bottle back on the humidifier bottle lid until it is tight. Be certain the bottle is screwed on straight. Cross-threading will cause oxygen to escape out the top of the bottle.

Twice Weekly Cleaning and Disinfection

It is very important to clean your humidifier bottle to

prevent infection. The following procedure should be done *twice a week*:

Step 1: Wash your hands as instructed on page 4.

Step 2: Turn the oxygen concentrator off.

Step 3: Remove the humidifier bottle.

Step 4: Wash the entire humidifier bottle in a solution of liquid detergent and warm water.

Step 5: Rinse the bottle thoroughly. Shake off the excess water.

Step 6: Mix together one part white vinegar and one part water.

Step 7: Soak the entire humidifier bottle for 30 minutes in the vinegar solution.

Step 8: Take the humidifier bottle out of the solution and rinse in warm tap water.

Step 9: Allow the humidifier bottle to air dry.

Step 10: Discard the vinegar solution.

Step 11: Replace your humidifier bottle as instructed above.

Oxygen Concentrator Troubleshooting

Trouble	Probable Cause	Remedy
No oxygen seems to be flowing from your system	Cannula or nipple adapter not connected tightly	Place the end of your cannula in a small glass of water and look for a steady flow of bubbles. If you can see the bubbles, your oxygen system is working fine.
		If you can't see any bubbles coming from both of your cannula prongs or if the bubbles have decreased in volume, check to see that the cannula is connected tightly to your oxygen system and that the nipple adapter is screwed on tightly.
		If using a humidifier, make sure that the lid is screwed on tightly and is not cross threaded.
Water blocking the oxygen tubing	Overfilling your humidifier bottle, or tubing that is lying on a cold floor	You should use your back-up oxygen system while attending to water in your tubing.
Unit not operating (power failure alarm sounds)	Plug not firmly in wall	Check plug at outlet.
	Concentrator circuit breaker has been set off	Press reset button.
	No power at wall outlet	Check power source (fuse or circuit breaker). Wall switch that controls plug may be switched off. Try another outlet.
	Electrical power outage	Use back-up oxygen system until power is restored.
Unable to dial prescribed flow rate	Obstructed humidifier bottle	Disconnect humidifier bottle. If flow is restored, replace with new humidifier bottle or use a nipple adapter.
	Obstruction in tubing	Disconnect tubing. If flow rate is restored, replace with new tubing.
	Obstruction in cannula	Disconnect cannula from tubing. If proper flow rate is restored, replace with a new cannula.

Oxygen Concentrator Troubleshooting *(Continued)*

Trouble	Probable Cause	Remedy
Temperature light/ alarm is on	Unit overheated	Check to see that unit is not obstructed by drapes, bedspread, wall, etc.
		Check to see that filters are clean.
		Turn unit off and go to your back-up system for 30 minutes while your concentrator is cooling. Restart your concentrator.
All other problems or alarms		Contact Apria Healthcare.

Travel Tips

Early planning and careful preparation are the keys to an enjoyable trip. The following tips should help you plan and prepare for any trip.

- Contact your physician to make sure your proposed trip is medically safe and to obtain additional copies of your prescription.
- Contact Apria Healthcare for assistance with getting oxygen refills along your driving route or at your final destination. Apria offers its Great Escapes™ program to assist with your travel arrangements. Contact Apria's Great Escapes National Travel Department **at least six weeks** prior to your travel date by calling us at **1 (844) 235-2738** and selecting the Travel Department.
- Have a check, money order or credit card available to pay for oxygen refills or equipment. Cash is not accepted.

If traveling by car or recreational vehicle:

- Remind passengers not to smoke in the vehicle in which you are traveling.
- Secure all cylinders in a manner that prevents them from moving within the vehicle. Cylinders may be stored upright or lying down as long as they are secure.
- Keep one window partially open to provide proper ventilation.
- **Do not** store oxygen in the trunk of your car.
- **Do not** store oxygen in an area where the internal or external temperature could reach 120 degrees Fahrenheit.
- When traveling in, or occupying a recreational vehicle, do not store oxygen near LP cylinders, LP tanks, or an open flame.
- Stay at least 5 feet away from all open flames, such as camp stoves, lanterns, and heaters.

If traveling by bus, train or ship:

- Contact the reservation office for specific information about the use of oxygen and special accommodations.
- Make sure to contact Apria **at least four weeks** in advance. There may be additional documentation, forms or releases required. There may also be additional fees required.

If traveling by airplane:

- Visit our website at apria.com, select **Apria's Travel Support**, then select **Portable Oxygen Concentrator request form**. Print this form, complete the patient page and have your physician complete the physician's page. Return these completed pages to your local Apria branch **at least three to four weeks** before your departure date.
- Many airlines also have forms that need to be completed by your physician. You should contact your airline provider to advise them that you will be travelling with oxygen and get any forms that they require.
- Request a direct flight, if one is available.
- Apria Healthcare offers its Great Escapes program to assist with your travel arrangements. Contact Apria Healthcare's Great Escapes National Travel Department **at least six weeks** prior to your travel date by calling us at **1 (844) 235-2738** and selecting the Travel Department.
- Most airlines allow patients to bring portable oxygen concentrators on board.

As part of Apria Great Escapes travel program, Apria can provide most patients with a portable oxygen concentrator that is allowed on most airlines.

- Before you depart on a plane, ensure that arrangements have been made to obtain oxygen at your final destination.

For further information, please contact Apria Healthcare's Great Escapes National Travel Department at **1 (844) 235-2738**, then select the Travel Department.

Feedback on Our Services

Apria Healthcare is among America's most experienced and respected home respiratory care providers, and our patient satisfaction scores are consistently high. It is possible, however, that you may have a concern and we welcome feedback. To voice a concern, you should take these steps:

1. Call the Apria Customer Service for Patient Concerns at **1 (800) 260-8808**
OR
2. Contact us by e-mail at:
Patient_Satisfaction@apria.com
OR
3. Visit our web site at **apria.com**

Satisfaction Survey Process

Our goal is to ensure your satisfaction. You will likely receive an Apria patient satisfaction questionnaire and we hope that you will take a few minutes to fill it out and return it to us. The postage is prepaid by Apria Healthcare.

Did you know that Apria Healthcare currently provides a home ventilator that can be used with a face or nasal mask? It's called *non-invasive ventilation*

Non-invasive ventilation is prescribed for patients with Chronic Respiratory Failure caused by severe Chronic Obstructive Pulmonary Disease (COPD) as well as other conditions that may result in a patient needing extra assistance with breathing.

Patients who benefit from non-invasive ventilation therapy typically have been diagnosed with severe COPD. They often have difficulty performing everyday activities due to shortness of breath; and this happens even though they may already be on oxygen therapy and/or using inhaled respiratory medications.

Are you a COPD patient who needs help to breathe easier?

Ask your doctor or your local Apria branch for more information. Certain qualification requirements do apply, and not all patients with COPD will require non-invasive ventilation.



What does COPD mean?

Chronic Obstructive Pulmonary Disease (COPD) is an umbrella term used to describe progressive lung diseases including emphysema, chronic bronchitis, refractory (non-reversible) asthma, and some forms of bronchiectasis.



APRIA HEALTHCARE®



APRIA HEALTHCARE®

Visit us at
apria.com

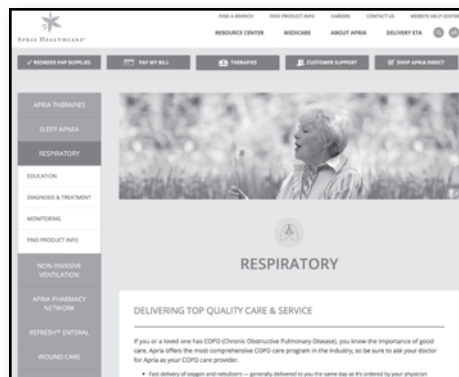

*Education
News
Articles
Services*