

TABLE OF CONTENTS

Introduction & Contraindications	2
Specifications	3
Warnings & Cautions	4
Unpacking the System	5
System Features	6
First Time Setup	8
Checking the Voltage	9
Installing the Filters	9
Power Cord	10
Assembling the Circuit	11
Accessories	13
Humidifier	13
Adding Oxygen to the System	13
DC Power System	14
Carrying Case	14
Routine Use	15
Connecting the Circuit	15
Adjusting the Circuit	15
Ramp Button	16
Turning the System Off	16
Helpful Hints	16
Traveling with the System	17
Routine Maintenance	19
Filters	19
Fuses	20
Cleaning	21
Reordering	21
Service	22
Troubleshooting	23
Warranty	25
Summary	27

INTRODUCTION

Intended Use

The REMstar LX and REMstar Plus LX CPAP Systems are for the treatment of adult Obstructive Sleep Apnea (OSA) only. The REMstar Plus LX and the REMstar LX deliver CPAP (Continuous Positive Airway Pressure) therapy. Your home care provider will make the correct pressure settings. The REMstar Plus LX device has a time meter that records the number of hours the System is in use. The REMstar LX device does not.

When prescribed by your physician, the ramp function allows you to lower the pressure when you are trying to fall asleep. The air pressure will gradually increase until your prescription pressure is reached. You also have the option of not using the ramp feature at all.

Several accessories are available to make your OSA treatment with the REMstar LX CPAP System as convenient and comfortable as possible and to ensure that you receive the safe, effective therapy prescribed for you.

IMPORTANT!

Read and understand the entire user's manual before operating this System. If you have any questions concerning the use of this System, contact your home care provider or doctor.

Contraindications

Studies have shown that the following pre-existing conditions may contraindicate the use of positive airway pressure therapy for some patients:

- Bullous Lung Disease
- Pneumocephalus
- Pneumothorax
- Pathologically Low Blood Pressure
- Pneumocephalus has been reported in a patient using nasal Continuous Positive Airway Pressure. Caution should be used when prescribing CPAP for susceptible patients such as those with: cerebral spinal fluid (CSF) leaks, abnormalities of the cribriform plate, prior history of head trauma, and/or pneumocephalus.
(Chest 1989; 96:1425-1426)

The use of positive airway pressure therapy may be temporarily contraindicated if you exhibit signs of a sinus or middle ear infection. Contact your physician if you have any questions concerning your therapy.

Specifications

Device Size

Dimensions: 10.00" x 5.50" x 4.75" (25x14x12 cm)
Weight: < 5 lb. (2.27 kg)

Product Use, Transport, and Storage

	Operation	Transport & Storage
Temperature:	41 - 104° F (5 - 40° C)	-4 - 140° F (-20 - 60° C)
Humidity:	30 - 75% Non-condensing	15 - 95% Non-condensing
Atmospheric Pressure:	76.7 - 102 kPascals	50 - 102 kPascals

Power Requirements

The electrical installation of the relevant room must comply with IEC requirements.

100-120 VAC / 230-240 VAC, 50/60 Hz, 1.0 A max.
12 VDC, 3 A DC max.

Type of protection against electric shock: Class II Equipment
Degree of protection against electric shock: Type BF Applied Part
Degree of protection against harmful ingress of water: Ordinary Equipment (IPXO)
Mode of Operation: Continuous

Device Fuses:

Line Voltage

115 VAC (100-120 VAC)

230 VAC (230-240 VAC)

Fuse Type

T 800 mA, 250 V, 5 x 20 mm

T 315 mA, 250 V, 5 x 20 mm

DC Cord Fuse (not included): 3 A, Time Delay, Type MDL

EMC Interference: Meets CISPR II, Class B Emissions Requirements

IMPORTANT!

Use **only** Respironics fuses supplied by your home care provider.

Symbol Key

 **Pressure ON / OFF**

 **Ramp**

 **DC Power**

 **Type BF Applied Part**

 **Fuse**

 **Class II (Double Insulated)**

 **Attention, consult accompanying documents**

 **European CE Declaration of Conformity**

WARNINGS & CAUTIONS

WARNING!

Indicates the possibility for injury to the user or the operator.

- This device is intended for adult use only.
- This device is not intended for life support.
- All CPAP devices have the potential to induce rebreathing of exhaled air. To reduce this potential, observe the following:
 - Use only Respironics circuit accessories
 - Do not wear the mask and headgear for more than a few minutes while the unit is not operating
 - Do not block or try to seal the vent holes in the exhalation port

As with most CPAP devices: At low CPAP pressures, the air flow through the exhalation port may not be enough to clear all of the exhaled gas (CO₂) from the mask. You may breathe in some of the air that you have exhaled.

- Under certain conditions, the temperature of the air flow from this device can be as much as 18° F (10° C) higher than the air temperature in the room. Caution should be exercised if the room temperature is warmer than 90° F (32° C).
- This equipment is not suitable for use in the presence of a flammable anesthetic mixture with air or with oxygen or nitrous oxide.
- To avoid electrical shock, disconnect the electrical supply before changing the fuses. For continued protection against risk of fire, replace fuses with those of the exact same type and rating only.
- The instructions in this manual are not intended to supersede established medical protocols.
- Contact your doctor if symptoms of sleep apnea recur.

CAUTION!

Indicates the possibility of damage to the device.

- U.S. federal law restricts this device to sale by or on the order of a physician.
- The voltage must be set for proper line voltage (e.g., North America - 115 V, Europe - 230 V).
- Should the noise level of the REMstar LX change to include unusual or harsh sounds during operation, discontinue use and contact your home care provider.
- Discontinue using the REMstar LX if any of the parts are damaged. Replace any damaged parts before continuing use.
- Tobacco smoke may cause tar build-up within the REMstar LX that may result in the REMstar LX malfunctioning.
- The REMstar LX is powered when the cord is connected to the main supply. The Pressure On/Off button enables/disables the blower only.
- The REMstar LX must be positioned on its base for proper operation.

Additional warnings and cautions are located throughout this manual as they apply.

UNPACKING THE SYSTEM

After unpacking the System, check to make sure you have everything shown here:

Note: REMstar *Plus* LX devices are equipped with a time meter. REMstar LX devices are not.

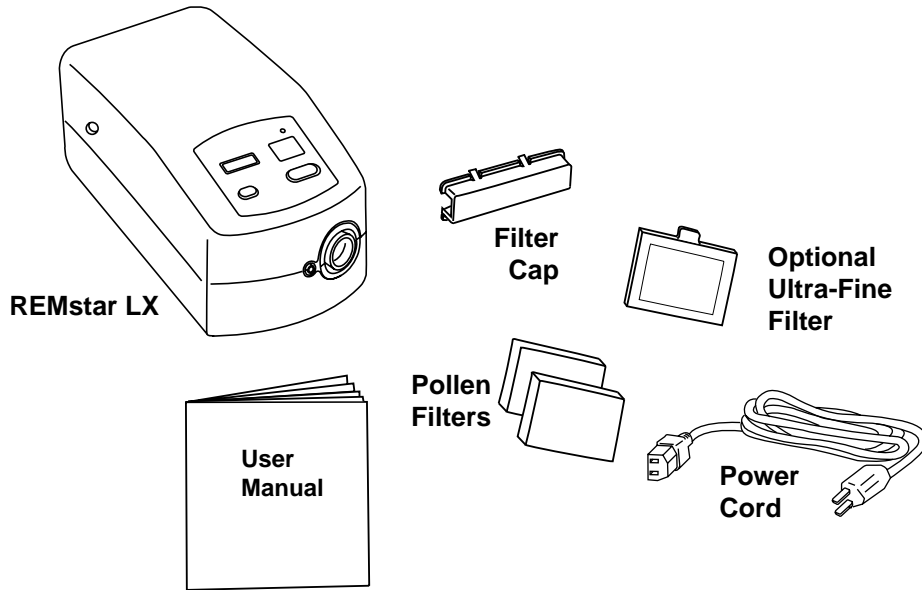

IMPORTANT!

If any of the above parts are missing, contact your home care provider.

Some REMstar LX Systems may also include one or more of the following accessories:

- 6 ft. (1.83 m) Flexible Tubing
- Exhalation Port
- Nasal Mask
- Humidifier
- Carrying Case

SYSTEM FEATURES

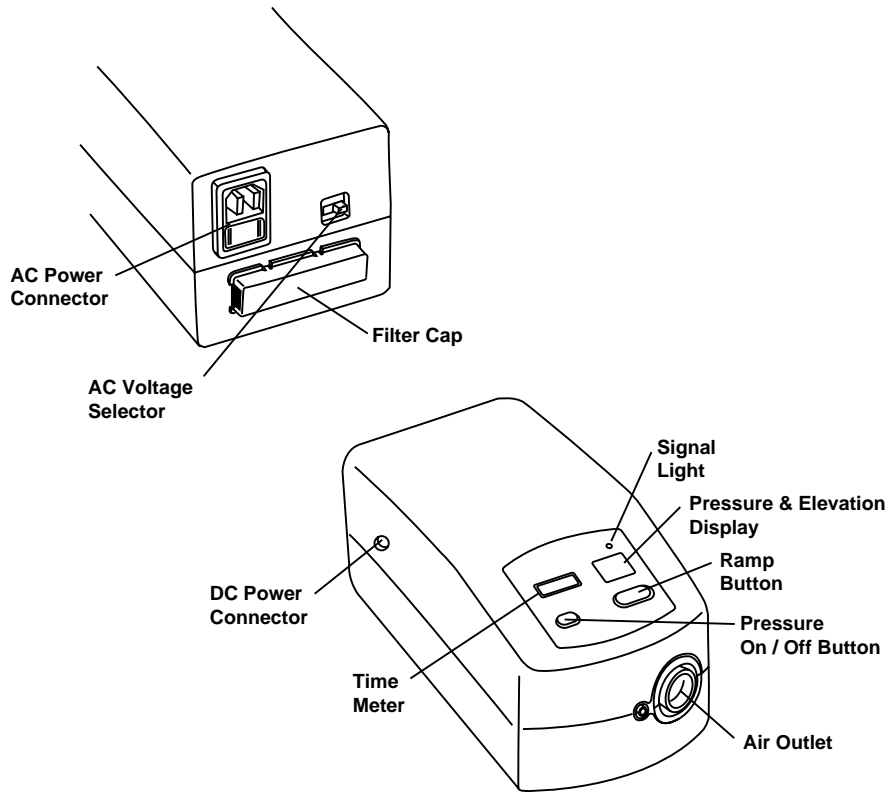

SYSTEM FEATURES

- AC Power Connector** Connect the AC power cord here.
- AC Voltage Selector** This switch is used to select the AC voltage (115V or 230V)
- Air Outlet** Connect flexible tubing here.
- DC Power Connector** Connect the optional DC power cord here.
- Filter Cap & Filters** The *pollen filter* screens out normal household dust and pollens. This must be in place at all times when the REMstar LX is operating. An optional, *ultra-fine filter* is also included for more complete filtration of very fine particles. (filters not shown)
- Fuse Compartment** This holds the AC fuses. Fuses must be changed if you change the voltage setting for travel (115 V / 230 V).
- Pressure On / Off**
- Button** This button turns the air flow on or off.
- Power Cord** Type H05VV-F. (not shown)
- Pressure & Elevation**
- Display** Displays the pressure and elevation settings.
- Ramp Button** This button decreases the pressure to the minimum pressure setting. When pressed, the pressure delivered will drop to 4 cm H₂O and then gradually increase to the prescribed pressure over the prescribed time period.
- Signal Light** The green light signals when the REMstar LX is powered, with the blower turned off.
- Time Meter** (REMstar Plus LX only) Displays the total operation time, including up to 200 hours of factory testing time. Provides resolution to 1/10 hour. Operates only when the airflow is turned on.

Medical Product Note: For ease at airport security stations, there is a note on the bottom of the REMstar LX stating that it is medical equipment. It may help if you also take this manual with you when you travel.

FIRST TIME SETUP

WARNING!

Do not use the REMstar LX CPAP System until an appropriate professional adjusts the settings!

To use the system, you may need the following accessories in order to assemble the circuit. Contact your home care provider to order these accessories. These items are not packaged with some of the Systems because of the multiple sizes and types available.

- Flexible Tubing -Respironics 6 ft. (1.83 m) flexible tubing with a smooth inner lumen and a 22 mm inner diameter
- Exhalation Port (e.g., Whisper Swivel[®] II or equivalent)

Note: This is not required if you are using a mask with a built-in exhalation port.

- Headgear
- Nasal Mask or other equivalent interface

To determine which circuit accessories are best for you, consult with your doctor or home care provider.

CAUTION!

If the REMstar LX has been exposed to either very hot or very cold temperatures, allow it to adjust to room temperature (approximately 2 hours) before beginning setup.

CAUTION!

When operating the REMstar LX System, make sure bedclothes, curtains, or other items are not blocking the filter cap openings or the vents on the REMstar LX. Make sure the REMstar LX is away from heating equipment (e.g., forced air vents, radiators).

IMPORTANT!

Large elevation changes will affect the pressure being delivered by the REMstar LX. Refer to the "Traveling with the System" section if you relocate or travel to areas with a significantly higher or lower elevation.

FIRST TIME SETUP

Checking the Voltage

1. Verify the voltage selection. Make sure the voltage selector switch on the back of the unit is set correctly (e.g., United States and Canada: 115V).

Note: If you change the voltage setting for travel, the fuses must also be changed.

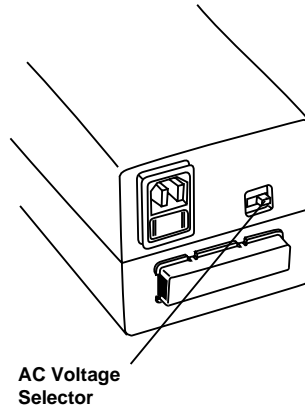

Installing the Filters

2. Install the filters in the back of the REMstar LX.

The pollen filter must be in place at all times when the REMstar LX is operating. The white ultra-fine filter is optional and can be used in addition to the pollen filter. The ultra-fine filter is recommended for people who are sensitive to tobacco smoke or other small particles.

- a. **Place one of the pollen filters over the ultra-fine filter.** Or, if you are not using the ultra-fine filter, simply place the pollen filter into the filter area on the back of the REMstar LX. An extra pollen filter is included for your convenience.
- b. **Attach the filter cap.** Position the opening on the side of the cap so that it is facing away from the bedside. Insert the cap's bottom tabs into the openings below the filter area. Press down on the cap's top tabs and insert them into the openings above the filter area.

FIRST TIME SETUP

Power Cord

3. Connect the power cord.

Plug the socket end of the power cord into the AC power cord connector on the back of the REMstar LX and the pronged end of the power cord into an electrical outlet.

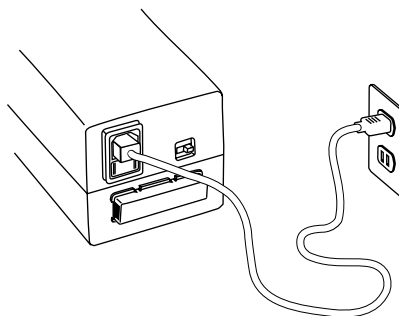

IMPORTANT!

An international plug adapter may also be required to make your power cord compatible with the electrical outlet of the country you are in. If further assistance is required, contact Respironics International Customer Service department at 1-800-345-6443 (US and Canada) or 1-412-731-2100.

CAUTION!

Do not use a voltage converter. It may cause damage to the REMstar LX. Use only Respironics approved power cords. Inspect the power cord often for any signs of damage. Replace a damaged cord immediately.

CAUTION!

The REMstar LX is activated when the power cord is connected. The Pressure On/Off button only turns the blower on/off.

4. Verify the elevation setting. (The air flow must be turned off.) Press the ramp button. The elevation setting will be displayed while the ramp button is depressed.

LO = less than 2,500 ft.

M = 2,500 - 5,000 ft.

HI = 5,001 - 7,500 ft.

*over 7,500 ft. = Contact your home care provider to have your pressure setting adjusted.

To change the elevation setting, press the ramp button and hold it down. While holding the ramp button down, press and release the pressure on/off button. Release the ramp button.

IMPORTANT!

DO NOT use the REMstar LX if the display is erratic. Contact your home care provider for further instructions.

Assembling the Circuit

5. **Assemble the circuit.** To use the System, you will need the following accessories in order to assemble the recommended circuit.

- *6 ft. (1.83 m) Flexible Tubing*
- *Nasal Mask with Exhalation Port*
- *Headgear*

WARNING!

If the REMstar LX is used for multiple persons (e.g., rental devices) a low-resistance, main flow bacteria filter should be installed in-line between the REMstar LX and the circuit tubing. Appropriate diagnostic pressures must be determined when a bacteria filter and other optional circuit accessories are in place.

- a. Connect the flexible tubing to the air outlet on the front of the REMstar LX.

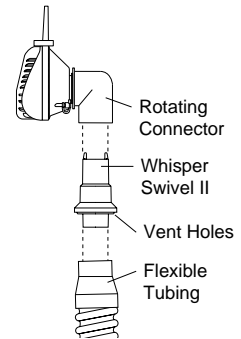

FIRST TIME SETUP

Assembling the Circuit

- b. If you are using a mask with a built-in exhalation port (e.g., Respironics Monarch® Mini Mask), connect the mask's connector to the flexible tubing.

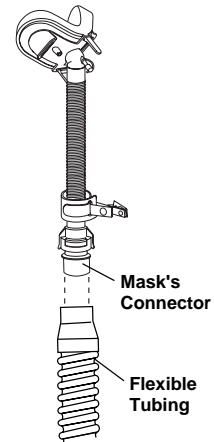

If you are using a mask with a separate exhalation port:

- Connect the exhalation port to the end of the flexible tubing.
- Position the exhalation port so that the vented air is blowing away from your face.
- Connect the mask's connector to the exhalation port.

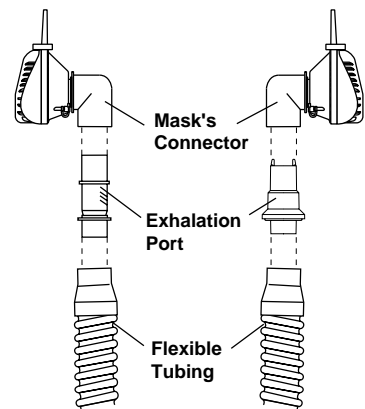

Note: The graphic to the right shows two different types of Whisper Swivel exhalation ports. Both ports are interchangeable, but the one shown on the right is a newer model. Respironics will no longer manufacture the port shown on the left.

WARNING!

The exhalation port is designed to exhaust CO₂ from the circuit. Continuous flow is required for safe operation. Do not block or otherwise try to seal the air openings on the exhalation port.

WARNING!

If you are using a full face mask (i.e., a mask covering both your mouth and your nose), the mask *must* be equipped with a safety (entrainment) valve.

Contact your home care provider for additional information on the accessories available for the REMstar LX System.

Adding a Humidifier *Humidifiers are available from your home care provider. The humidifiers may reduce nasal dryness and irritation by adding moisture to the air flow.*

WARNING!

For safe operation, the humidifier must always be positioned below the circuit connection at the mask and the air outlet on the REMstar LX unit. The humidifier must be level for proper operation.

CAUTION!

When using a humidifier, always disconnect the humidifier tubing from the REMstar LX System when it is turned off. **DO NOT** use a room humidifier within six feet (1.83 m) from the REMstar LX. Moisture can build up in the System and cause damage. Follow the instructions included with the humidifier.

CAUTION!

When using a heated humidifier, avoid using the high temperature setting which may cause water to collect in the tubing.

Adding Oxygen to the System

When using supplemental oxygen with the REMstar LX, a Respironics Pressure Valve (Part Number 302418) must be placed in-line with the patient circuit. Oxygen may be added at the mask connection. Please note the warnings listed below.

WARNING!

When using oxygen with the REMstar LX System, turn the REMstar LX on before turning the oxygen on. Turn the oxygen off before turning the REMstar LX off. This will prevent oxygen accumulation in the REMstar LX.

WARNING!

Oxygen accelerates fires. Keep the REMstar LX and the oxygen container away from heat, open flames, or other sources of ignition. **DO NOT** smoke in the area near the REMstar LX or the oxygen.

ACCESSORIES

Using a DC Power System

You can also use the REMstar LX in a stationary recreational vehicle, boat or motor home with a 12 volt DC power source. The REMstar LX should not be operated while the vehicle is in motion. Contact your home care provider for additional information.

CAUTION!

Only use the Respironics DC Power System available from your home care provider. Use of any other system may cause damage to the REMstar LX or your vehicle.

CAUTION!

DC Power is not intended to be used as battery back-up. DO NOT connect the DC Power System while the REMstar LX is operating on AC power. System damage may occur.

Carrying Case

The carrying case holds the REMstar LX and accessories. When traveling by airplane, the carrying case is for carry-on luggage only. Never check the REMstar LX through the baggage department.

Connecting the Circuit

1. Connect the circuit. Before each use, examine the flexible tubing for any damage or debris. If necessary, clean the tubing to remove the debris. Replace any damaged tubing.
 - a. Connect the mask to the headgear, following the instructions included with the headgear. Press the Pressure On/Off button on the top of the REMstar LX to turn the air flow ON.

When the Pressure On/Off button is depressed, the pressure and altitude settings will be displayed briefly for you to verify.

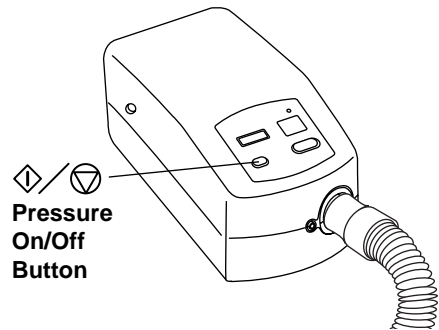

- b. Put on the mask and headgear, and breathe normally through your nose.

Adjusting the Circuit

2. Adjust the circuit.
 - a. Lie down on your bed and adjust the flexible tubing so it is free to move if you turn in your sleep.
 - b. Adjust the mask and headgear until you have a comfortable fit and there are no air flow leaks into your eyes.

When the air flow is on, the green signal light will go out.

ROUTINE USE

Using the Ramp Button

Pressing the Ramp button will reduce the air pressure when you are trying to fall asleep. The air pressure will gradually increase until your prescription pressure is reached. You also have the option of not using the ramp feature at all.

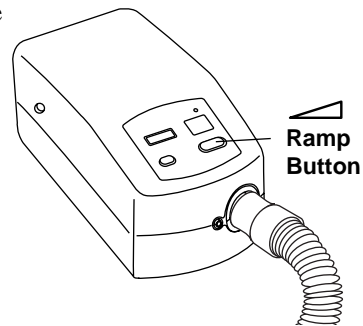

3. Press the Ramp button on the top of the REMstar LX. You can use the Ramp button as often as you wish during the night. (NOTE: After the first activation, each subsequent ramp will be for one-half of the set ramp time.)

CAUTION!

When using a humidifier, *you must* disconnect the humidifier tubing from the REMstar LX System when the air flow is turned off. Moisture can build up in the System and cause damage to it.

Turning the System OFF

4. Press the Pressure On/Off button on the top of the REMstar LX to turn the air flow OFF.

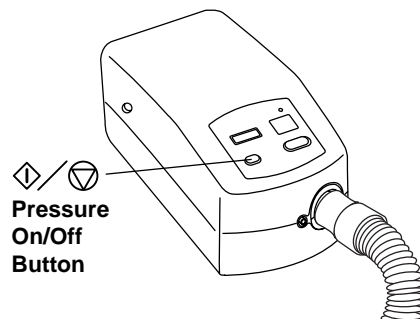

Helpful Hints

- If you want to talk after putting on the mask, use the Ramp button to reduce the pressure. This will make talking easier.
- Make sure that bedding, curtains, or other items are not blocking the filter or vents of the REMstar LX. Air must flow freely around the REMstar LX for the System to work properly.
- If the air flow from the REMstar LX feels cold, reposition the circuit tubing so that it runs under your bed covers to reduce heat loss while you sleep.

TRAVELING WITH THE SYSTEM

Packing the System

When traveling, the optional carrying case is for carry-on luggage *only*. The carrying case will not protect the System if it is put through checked baggage.

Security Stations

For ease at security stations, there is a note on the bottom of the REMstar LX stating that it is medical equipment. It may be helpful to bring this manual along with you to help security personnel understand the REMstar LX.

Checking the Power Cord

If you are traveling to a country with a line voltage different than the one you are currently using, an international plug adapter may be required to make your power cord compatible with the power outlets of the country to which you are traveling.

Changing the Voltage and Fuses

If you need a plug adapter, you will probably need to change the voltage setting (115 V or 230 V) and the fuses. Change the voltage setting and install the appropriate fuses into the REMstar LX before traveling. Contact your home care provider to order fuses. (See the instructions for changing the fuses in the “Routine Maintenance” section.)

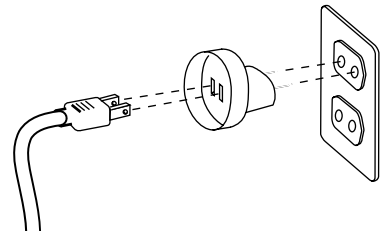

Contact Respiration International Customer Service department at 1-800-345-6443 (in the U.S. and Canada) or 1-412-731-2100 for more information.

Line Voltage:

115 VAC (100-120 VAC)

230 VAC (230-240 VAC)

Fuse Type:

T 800 mA, 5 x 20 mm

T 315 mA, 5 x 20 mm

CAUTION!

Do not use a voltage converter. It may cause damage to the REMstar LX.

TRAVELING WITH THE SYSTEM

Changes in Elevation

Elevation changes can affect the pressure being delivered by the REMstar LX. At elevations *less than 2,500 ft. (762 m)*, the REMstar LX should be set to the *low* setting. In areas with elevations between 2,500 ft. and 5,000 ft. the REMstar LX should be set to the medium setting. In areas with elevations of 5,000 ft. or *higher*, the REMstar LX should be set to the *high* setting.

To verify the elevation setting:

1. Make sure the REMstar LX is plugged in and the air flow is turned OFF.
2. Press the ramp button. The elevation setting will be displayed while the ramp button is depressed.
 - LO - less and 2,500 ft.
 - M - 2,500 - 5,000 ft.
 - Hi - over 5,000 ft.

To change the elevation setting:

1. Make sure the REMstar LX is plugged in and the air flow is turned OFF.
2. Press the ramp button and hold it down. While holding the ramp button down, press and release the pressure on/off button. Release the ramp button.
3. Verify the elevation setting. Press the ramp button. The elevation setting will be displayed while the ramp button is depressed.

ROUTINE MAINTENANCE

Cleaning and Replacing the Filters

The **gray pollen filter** should be cleaned at least once every two weeks under normal usage and replaced with a new one every six months.

The **white ultra-fine filter** is disposable and should be replaced after 30 nights of use or sooner if it appears dirty. **DO NOT** clean the ultra-fine filter.

CAUTION!

Operating the REMstar LX with a dirty filter may keep the system from working properly and damage the REMstar LX.

1. Remove the filter cap by gently pressing down on the two latches on the top of the filter cap.

2. Change the filters.

a. Remove the pollen filter by gently pulling around the edges of the filter. Rinse the filter in a steady stream of running water. Squeeze out the water and repeat. Air dry on a rack for 8 to 12 hours or in a clothes dryer for 15 to 20 minutes.

If you are using the white ultra-fine filter, and it appears dirty, discard the filter and replace it with a new one.

b. Place the white ultra-fine filter under the clean pollen filter. Insert the filter(s) into the filter area on the back of the REMstar LX.

CAUTION!

Never install a wet filter into the REMstar LX. We recommend that you clean the filter in the morning and alternate using the two pollen filters provided with the System to ensure enough drying time for the cleaned filter.

3. Replace the filter cap.

ROUTINE MAINTENANCE

Changing the Fuses

If the REMstar LX does not turn ON when the power cord is plugged in, the fuses may need to be replaced. The fuses are located in the back of the REMstar LX above the power cord connector.

CAUTION!

If you change the voltage setting, the fuses *must* be changed.

WARNING!

Unplug the REMstar LX before changing the fuses. Use only Respironics fuses supplied by your home care provider.

1. Remove the fuse holder by releasing the small tabs on the sides of the holder. You may need a small screwdriver to help remove the holder.
2. Replace the old fuses with new fuses of the same type and rating. Use only Respironics fuses supplied by your home care provider. Always replace *both* fuses.

Line Voltage:

115 VAC (100-120 VAC)

230 VAC (230-240 VAC)

Fuse Type:

T 800 mA, 5 x 20 mm

T 315 mA, 5 x 20 mm

3. Insert the fuse holder back into the REMstar LX and snap into place.

ROUTINE MAINTENANCE

Cleaning the System

WARNING!

To avoid electrical shock, unplug the REMstar LX before cleaning. Do not immerse the REMstar LX into any fluids.

- 1. Disconnect the flexible tubing from the REMstar LX. Gently wash the flexible tubing and the tubing swivel in a solution of warm water and a mild detergent. Rinse thoroughly. Air dry.**
2. Wipe the outside of the REMstar LX with a cloth slightly dampened with water and a mild detergent. Let the REMstar LX dry before plugging in the power cord.
3. Inspect the REMstar LX and all circuit parts for any damage after cleaning. Replace any damaged parts.

Reordering

Contact your home care provider to order accessories or replacement filters and fuses.

ROUTINE MAINTENANCE

Service

The REMstar LX System does not require routine servicing.

- If symptoms of sleep apnea recur, contact your physician.
- If you think the REMstar LX is not performing properly or is not delivering the correct air pressure, contact your home care provider.
- If the noise level of the REMstar LX has changed to include unusual or harsh sounds during operation, contact your home care provider or Respironics for instructions on having the REMstar LX serviced.

WARNING!

If the REMstar LX malfunctions, contact your home care provider immediately. Never attempt to open the REMstar LX's enclosure.

MAINTENANCE RECORD

Filter(s) Replaced

Mask Replaced

Pressures Checked

Hours on Time Meter

(REMstar Plus LX only)

TROUBLESHOOTING

The table below lists common problems you may have with the REMstar LX System and possible solutions to those problems. If none of the corrective actions solve the problem, contact your home care provider.

Problem

Solutions

Sore or dry eyes

Readjust the headgear. Contact your home care provider to be fitted for a different mask style or size.

Redness on your face where the mask contacts your skin

Loosen the headgear. Check the mask's spacer to see that it is in good condition. Use a barrier between your skin and the mask, such as 3M's Microfoam™ tape, Squibb's Duoderm™ or Hollister's Restore™. If you are using Respiroics' Contour Nasal Mask, try adding a Comfort Flap® mask accessory. Contact your home care provider to be fitted for a different mask style or size. Contact your doctor if the problem persists.

Dryness or burning sensation in your throat or nose

Consult with your doctor or home care provider about using a humidifier with the REMstar LX. If you are using a nasal mask, you may want to also use a chin strap to help keep your mouth closed during the night.

Nasal, sinus, or ear pain

You may have a sinus infection or middle ear infection. Stop using the REMstar LX and contact your doctor.

The pressure being delivered feels different

Check the elevation setting to be sure it is set to your elevation. Change the elevation setting if necessary. If the elevation setting is correct, contact your home care provider or Respiroics, Inc. for directions on having the REMstar LX serviced. Please have the REMstar LX's serial number ready when you call.

TROUBLESHOOTING

Problem

Solutions

The air flow from the REMstar LX seems warm.

Replace or clean the filter. Make sure the REMstar LX is away from bedding or curtains that could block the flow of air around the REMstar LX. Make sure the REMstar LX is away from heating equipment (e.g., forced air vents, radiators).

The REMstar LX is making a faint humming sound when the air flow is turned off.

This is a normal characteristic of the REMstar LX. If the humming sound is significantly louder than it usually is, contact your home care provider or Respironics for directions on having the REMstar LX serviced. Please have the REMstar LX's serial number ready when you call.

The noise level of the REMstar LX has changed to include unusual or harsh sounds during operation.

Contact your home care provider or Respironics for directions on having the REMstar LX serviced. Please have the REMstar LX's serial number ready when you call.

The REMstar LX will not turn on.

Make sure that the REMstar LX is plugged into a working outlet. Replace the REMstar LX's fuses if the green signal light does not come on. Verify that the correct voltage has been selected (i.e., if your electrical line is 115 V you must use the 115 V voltage setting). Press the Pressure On/Off button. If the new fuses blow out, contact your home care provider. If you are using a DC battery, the battery may need to be recharged or replaced or the fuses may need to be replaced.

The REMstar Plus LX has hours recorded on the time meter when it is delivered.

The REMstar Plus LX is tested at the factory prior to shipment. It is normal for up to 200 hours of testing time to be recorded on the REMstar Plus LX.

LIMITED WARRANTY

Respironics, Inc.[®] warrants that the REMstar[®] LX CPAP device shall be free from defects of workmanship and materials and will perform in accordance with the product specifications for a period of two (2) years from the date of sale by Respironics, Inc. to the dealer. If the product fails to perform in accordance with the product specifications, Respironics, Inc. will repair or replace, at its option, the defective material or part. Respironics, Inc. will pay customary freight charges from Respironics, Inc. to the dealer location only. This warranty does not cover damage caused by accident, misuse, abuse, alteration and other defects not related to material or workmanship.

RESPIRONICS, INC. DISCLAIMS ALL LIABILITY FOR ECONOMIC LOSS, LOSS OF PROFITS, OVERHEAD OR CONSEQUENTIAL DAMAGES WHICH MAY BE CLAIMED TO ARISE FROM ANY SALE OR USE OF THIS PRODUCT. SOME STATES DO NOT ALLOW THE EXCLUSION OR LIMITATION OF INCIDENTAL OR CONSEQUENTIAL DAMAGES, SO THE ABOVE LIMITATION OR EXCLUSION MAY NOT APPLY TO YOU.

THIS WARRANTY IS GIVEN IN LIEU OF ALL OTHER EXPRESS WARRANTIES. IN ADDITION, ANY IMPLIED WARRANTIES, INCLUDING ANY WARRANTY OF MERCHANTABILITY OR FITNESS FOR THE PARTICULAR PURPOSE ARE LIMITED TO TWO YEARS. SOME STATES DO NOT ALLOW LIMITATIONS ON HOW LONG AN IMPLIED WARRANTY LASTS, SO THE ABOVE LIMITATION MAY NOT APPLY TO YOU. THIS WARRANTY GIVES YOU SPECIFIC LEGAL RIGHTS, AND YOU MAY ALSO HAVE OTHER RIGHTS WHICH VARY FROM STATE TO STATE.

To exercise your rights under this warranty, contact your local, authorized Respironics, Inc. dealer or Respironics, Inc. at 1001 Murry Ridge Lane, Murrysville, Pennsylvania 15668, 1-800-345-6443 or 1-412-731-2100.

LIMITED WARRANTY

The REMstar LX and REMstar Plus LX CPAP devices carry a two-year warranty. A warranty/comment card should be included with this manual for your completion. If it is not, contact Respironics' Warranty Administrator at 1-800-666-2901 or 1-412-731-2100 to register your equipment and receive a FREE package of ultra-fine filters.

For Information on Sleep Disorders Contact:

**American Sleep Apnea Association
2025 Pennsylvania Ave. N.W., Suite 905
Washington D.C. 20006
Telephone: 1-202-293-3650**

**National Sleep Foundation
1367 Connecticut Ave. N.W., Suite 200
Washington D.C. 20036
Telephone: 1-202-785-2300**

SUMMARY

This summary is not intended to replace the complete user instructions. The entire manual should be read and understood before operating the REMstar LX System.

Step 1 Check that the correct voltage setting has been selected (e.g., N. America - 115 V, Europe - 230 V). Change the voltage setting and fuses, if necessary.

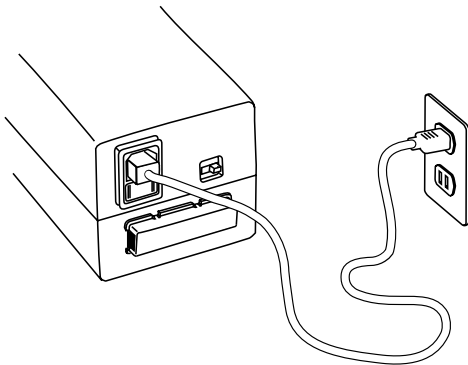
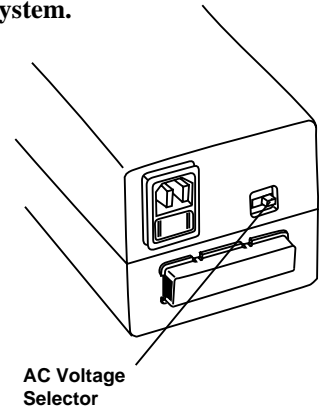

Step 2 Plug the power cord into the AC power cord connector and an electrical outlet.

Step 3 Press the ramp button to verify that the correct elevation setting has been selected.

To change the elevation setting, press the ramp button and hold it down. While holding the ramp button down, press and release the pressure on/off button. Release the ramp button.

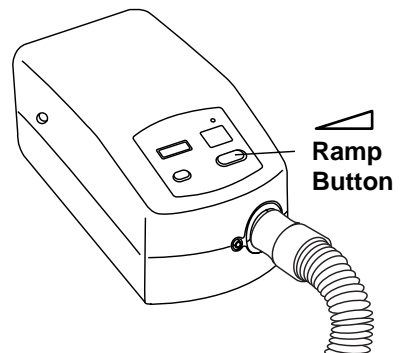

SUMMARY

Step 4 Connect the flexible tubing, exhalation port, and mask. Adjust the mask and headgear.

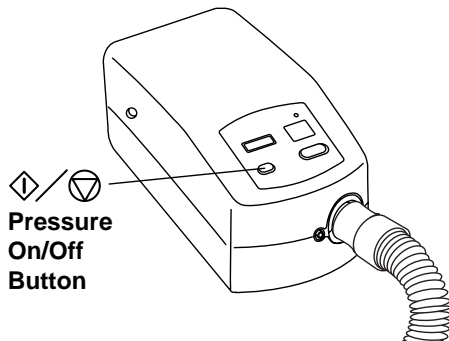
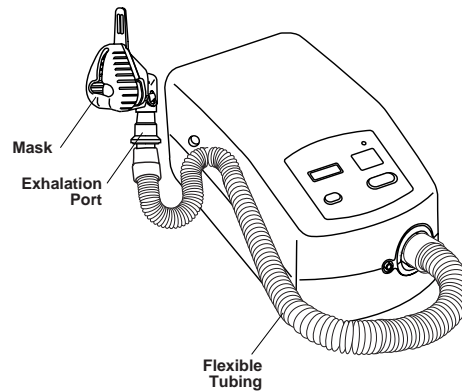

Step 5 Turn the air flow on or off by pressing the Pressure On/Off button.

When the Pressure On/Off button is pressed, the pressure and altitude settings will be displayed briefly for you to verify.

Step 6 (Optional) Press the Ramp button to reduce the pressure.

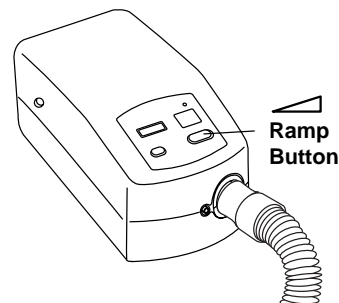

IMPORTANT!

**Fill in the information below when you receive
the REMstar® LX or REMstar Plus LX CPAP System.**

REMstar LX Serial No.: _____ (Located on the bottom of the REMstar LX)

System Prescribed for: _____

Date of Purchase or Rental: _____

Pressure Setting: _____ cm H₂O

Mask Type: _____

Mask Size: _____

Comfort Flap® Nasal Mask Accessory: yes no

If you have any questions concerning the System, contact:

• Home Care Company: _____

 Telephone Number: _____

• Doctor: _____

 Telephone Number: _____

• Respironics, Inc.

 1001 Murry Ridge Lane

 Murrysville, Pennsylvania

 15668-8550 U.S.A.

 Customer Service

 Telephone Number: 1-800-345-6443 or 1-412-731-2100

REMstar LX, and REMstar Plus LX CPAP Systems are the subject of U.S. patent #5,239,995.
Other patents pending. REMstar LX, Whisper Swivel, Monarch, GoldSeal, Spectrum, Plateau,

Oasis, and Comfort Flap are trademarks of Respironics, Inc.

© Respironics, Inc. 1998