

RESPIRONICS®

BiPAP® | autoSV™ with Encore SmartCard®

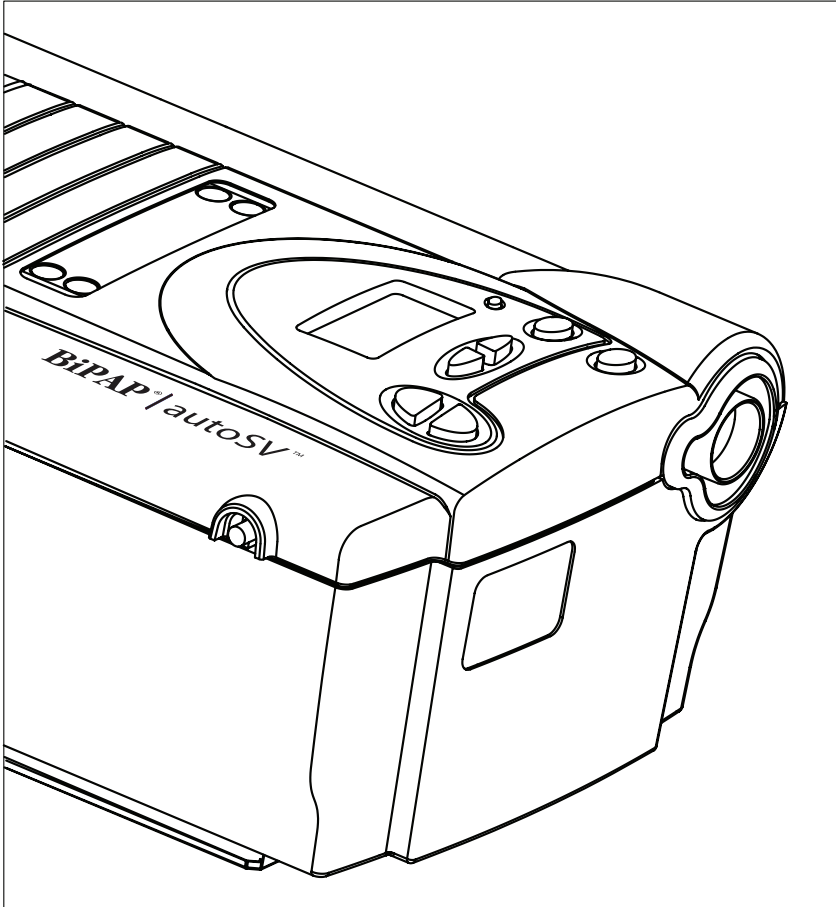

User Manual

This BiPAP system is covered by one or more of the following patents: U.S. Patent Nos. 5,148,802; 5,239,995; 5,313,937; 5,433,193; 5,632,269; 5,803,065; 6,029,664; 6,305,374 and 6,539,940; Australian Patent Nos. 638054; 661575; 698519; 723681; 734319 and 733655; Canadian Patent Nos. 2,024,477; 2,162,981 and 2,259,795; European Patent No. EP0425092; German Patent No. 69021681.5-08; and Japanese Patent Nos. 2832812; 2137336; and 2926392. Other U.S. and foreign patents pending.

TABLE OF CONTENTS

CHAPTER 1: PACKAGE CONTENTS	I
CHAPTER 2: WARNINGS AND CAUTIONS	2
2.1 WARNINGS.....	2
2.2 CAUTIONS	4
2.3 INTENDED USE.....	4
2.4 CONTRAINDICATIONS.....	4
2.5 PRECAUTIONS	4
CHAPTER 3: INTRODUCTION TO THE DEVICE	5
3.1 DEFINITIONS.....	5
3.2 WHAT IS BI-LEVEL VENTILATION?.....	5
3.3 WHAT IS THE BiPAP AUTO SV DEVICE?	6
3.4 SYMBOLS	7
3.5 HOW TO CONTACT RESPIRONICS	7
CHAPTER 4: DEVICE CONTROLS AND DISPLAY FEATURES	8
4.1 PRESSURE ON/OFF BUTTON.....	8
4.2 CONTROL PANEL.....	9
4.2.1 CONTROL BUTTONS.....	9
4.2.2 ALARM AND POWER INDICATORS	10
4.2.3 DISPLAY SCREEN.....	10
4.2.4 BREATHING CIRCUIT CONNECTION.....	12
4.2.5 REAR PANEL	12
CHAPTER 5: SETTING UP THE BiPAP AUTO SV DEVICE	13
5.1 INSTALLING THE AIR FILTERS	13
5.2 WHERE TO PLACE THE DEVICE	14
5.3 CONNECTING THE BREATHING CIRCUIT	14
5.4 COMPLETE SETUP.....	16
5.5 PLUGGING THE DEVICE IN.....	16
5.5.1 USING AC POWER	16
5.5.2 USING DC POWER.....	17
CHAPTER 6: OPERATING THE DEVICE.....	18
6.1 STARTING THE DEVICE.....	18
6.2 CHANGING THE DEVICE SETTINGS.....	20
6.2.1 CHANGING THE HUMIDIFIER SETTING.....	20
6.2.2 NAVIGATING THE USER DISPLAY SCREENS	21
6.2.2.1 CHANGING THE RISE TIME SETTING	21
6.2.2.2 CHANGING THE RAMP STARTING PRESSURE.....	22
6.2.2.3 CHANGING THE LED BACKLIGHT SETTING.....	22
6.3 MONITORING MEASURED PARAMETERS	23

CHAPTER 7: ALARMS	25
7.1 INTRODUCTION TO ALARMS	25
7.2 WHAT TO DO WHEN AN ALARM OCCURS.....	26
7.3 ALARM TABLES.....	27
7.3.1 HIGH PRIORITY ALARMS.....	27
7.3.2 MEDIUM PRIORITY ALARMS	28
7.3.3 LOW PRIORITY ALARMS.....	28
CHAPTER 8: TROUBLESHOOTING	29
CHAPTER 9: CLEANING AND MAINTENANCE	32
9.1 CLEANING THE DEVICE	32
9.2 CLEANING OR REPLACING THE INLET FILTERS	32
9.3 CARRYING CASE.....	33
CHAPTER 10: ACCESSORIES	34
10.1 ADDING A HUMIDIFIER	34
10.2 ADDING OXYGEN TO THE DEVICE.....	34
CHAPTER 11: SPECIFICATIONS	35
APPENDIX A: EMC INFORMATION	37

CHAPTER 1: PACKAGE CONTENTS

Your BiPAP autoSV device should include the following items. If any of these items are missing, contact your health care professional.

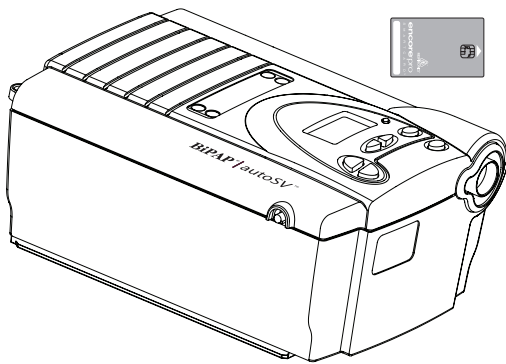

**BiPAP autoSV with
Encore SmartCard**

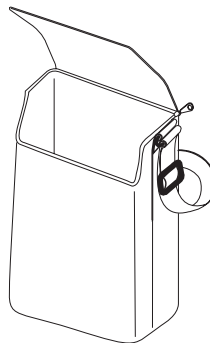

Carrying Case

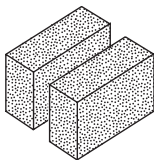

**Reusable Gray
Foam Filters**

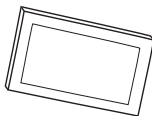

**Disposable
Ultra-fine Filter**

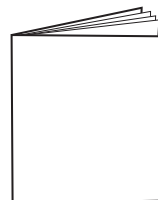

User Manual

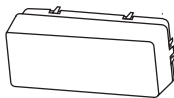

Filter Cap

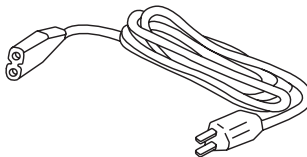

Power Cord

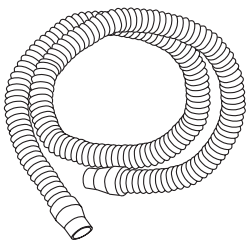

**Flexible Tubing
1.83 m (6 ft.) x 22 mm i.d.**

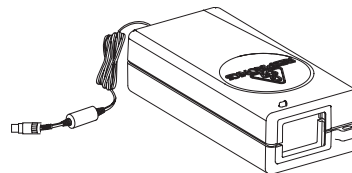

External AC Power Supply

User Manual

CHAPTER 2: WARNINGS AND CAUTIONS

WARNING: Indicates the possibility of injury to the user or operator.

CAUTION: Indicates the possibility of damage to the device.

NOTE: Places emphasis on an operating characteristic.

Caution: *U.S. federal law restricts this device to sale by or on the order of a physician.*

2.1 WARNINGS

- This manual serves as a reference. The instructions in this manual are not intended to supersede the instructions of your health care professional. You should read and understand this entire manual before using the device.
- Long term effects of the treatment of sleep disordered breathing and/or Cheyne Stokes Respiration in patients with Congestive Heart Failure (CHF) or atrial fibrillation have not been documented. Therefore, caution should be exercised when using this device on a patient with CHF or atrial fibrillation. The clinician should assess the relative risk and benefits of the therapy on a case-by-case basis.
- The prescription must be adjusted only by a trained health care professional.
- The device provides positive pressure ventilation and is indicated for assisted ventilation. This system does not provide ventilation with guaranteed tidal volume delivery. Patients requiring ventilation at predetermined tidal volumes are not candidates for pressure support ventilation.
- This is not a life support ventilator. *BiPAP autoSV* is a non-continuous ventilator intended to augment patient breathing. It is not intended to provide total ventilatory support. It may stop operating with power failure or if a fault occurs in the product.
- You should report unusual chest pain, severe headache or increased breathlessness to your health care professional.
- At low EPAP pressures, the flow through the exhalation port may be inadequate to clear all exhaled gas from the tubing. Some rebreathing may occur.
- If the patient has a severe obstructive or restrictive spirometric defect, or severe daytime hypercapnia or hypoxia, then the device may not be an appropriate treatment method. This is due to the level of ventilatory support that the *BiPAP autoSV* provides.
- Do not connect any equipment to the device unless recommended by Respirationics or the health care professional. Verify that an exhalation port is present to exhaust CO₂ from the circuit. If circuit accessories other than those recommended by Respirationics are connected to the device, then pressure must be verified. Use of these accessories may alter the pressure received, reducing the effectiveness of treatment.
- The device should be used only with masks and connectors recommended by Respirationics or with those recommended by the health care professional or respiratory therapist. A mask should not be used unless the device is turned on and operating properly. The exhalation port(s) associated with the mask should never be blocked. In the event of a power failure or machine malfunction, remove the mask.

Explanation of the Warning: The device is intended to be used with special masks or connectors that have exhalation ports to allow continuous flow of air out of the mask. When the device is turned on and functioning properly, new air from the device flushes the exhaled air out through the mask exhalation port. However, when the device is not operating, enough fresh air will not be provided through the mask, and exhaled air may be rebreathed. Rebreathing of exhaled air for longer than several minutes can in some circumstances lead to suffocation.

- When the device is used with an external humidifier, position the humidifier so that the water level in the humidifier is lower than you, and the humidifier is on the same level or lower than the device.
- Do not open the *BiPAP autoSV* enclosure. There are no user serviceable parts inside. Repairs and internal servicing should only be performed by an authorized service agent.
- Periodically inspect electrical cords for damage or signs of wear.
- To avoid electrical shock, unplug the device before cleaning.
- If you detect any unexplained changes in the performance of the device, if it is making unusual or harsh sounds, if it has been dropped or mishandled, if the enclosure is broken, or if water has entered the unit, discontinue use and contact your home care provider.
- Pins of connectors identified with the ESD warning symbol should not be touched. Connections should not be made to these connectors unless ESD precautionary procedures are used. Precautionary procedures include methods to prevent build-up of electrostatic discharge (e.g., air conditioning, humidification, conductive floor coverings, non-synthetic clothing), discharging one's body to the frame of the equipment or system or to earth or a large metal object, and bonding oneself by means of a wrist strap to the equipment or system or to earth.
- Do not use the device if the room temperature is above 95° F (35° C). If the device is used at room temperatures above 95° F (35° C), the temperature of the airflow may exceed 106° F (41° C), which could cause irritation to your airway.
- Do not operate the device in direct sunlight or near a heating appliance because these conditions can increase the temperature of the air coming out of the device.
- Oxygen supports combustion. Oxygen should not be used while smoking or in the presence of an open flame.
- Do not use the device in the presence of a flammable anaesthetic mixture in combination with oxygen or air, or in the presence of nitrous oxide.
- If oxygen is used with the device, the oxygen flow must be turned off when the device is not in use.

Explanation of the Warning: When the device is not in operation and the oxygen flow is left on, oxygen delivered into the tubing may accumulate within the device's enclosure. Oxygen accumulated in the device enclosure will create a risk of fire.

- If you are using oxygen, the device must be equipped with the Respironics Pressure Valve. Failure to use the Pressure Valve could result in a fire hazard.

2.2 CAUTIONS

- The device may only be operated at temperatures between 41° F (5° C) and 95° F (35° C).
- A properly installed, undamaged reusable foam inlet filter is required for proper operation.
- Do not immerse the device or allow any liquid to enter the enclosure or the inlet filter.
- Do not place the device in or on any container that can collect or hold water.
- Condensation may damage the device. Always allow the device to reach room temperature before use.
- Use the power cable retainer to keep the power cord from being unintentionally disconnected.

NOTE: Additional warnings, cautions, and notes are located throughout this manual.

2.3 INTENDED USE

The BiPAP autoSV is intended to provide non-invasive ventilatory support to treat adult patients with OSA and Respiratory Insufficiency caused by central and/or mixed apneas and periodic breathing.

2.4 CONTRAINDICATIONS

The device should not be used if you have severe respiratory failure without a spontaneous respiratory drive.

If any of the following conditions apply to you, consult your physician before using the device:

- Hypotension or significant intravascular volume depletion
- At risk for aspiration of gastric contents
- Acute sinusitis or otitis media
- Epistaxis (severe nose bleeds), causing a risk of pulmonary aspiration of blood
- Impaired ability to clear secretions
- Pneumothorax or pneumomediastinum
- Recent cranial trauma or surgery
- Chronic hypoventilation

NOTE: When assessing the relative risks and benefits, the health care professional should understand that the device can be set to deliver pressures up to 30 cm H₂O. Also, in the unlikely event of certain fault conditions, a maximum static pressure of 40 cm H₂O is possible.

2.5 PRECAUTIONS

- The following are potential side effects of noninvasive positive pressure therapy:
 - Ear or sinus discomfort
 - Conjunctivitis
 - Skin abrasions due to noninvasive interfaces
 - Gastric distention (aerophagia)
 - Drying of nose, mouth or throat
 - Eye irritation
 - Skin rashes
 - Chest discomfort

CHAPTER 3: INTRODUCTION TO THE DEVICE

3.1 DEFINITIONS

The following terms appear throughout this manual:

Apnea	A condition marked by the cessation of spontaneous breathing.
BPM	Breaths Per Minute
CPAP	Continuous Positive Airway Pressure
EPAP	Expiratory Positive Airway Pressure
Exhaled Tidal Volume (V_{TE})	The exhaled volume of each breath
High Priority Alarm	An alarm signal indicating a condition that requires immediate attention.
IPAP	Inspiratory Positive Airway Pressure
LED	Light Emitting Diode
LEAK	The amount of airflow leak detected by the device.
Low Minute Ventilation	A condition in which you are not receiving a specified volume of air on a per minute basis.
Low Priority Alarm	An alarm signal indicating an informational message.
Medium Priority Alarm	An alarm signal indicating a condition that requires operator awareness.
Minute Ventilation (MinVent)	The volume of air received by the patient on a per minute basis.
Operate State	The state of the device when the device and the airflow are both on.
OSA	Obstructive Sleep Apnea
Ramp	A feature that may increase patient comfort when therapy is started. The ramp feature reduces the pressure and then gradually increases (ramps) the pressure to the prescription setting, so you can fall asleep more comfortably.
Respiratory Rate (RR)	The patient's rate of respiration.
Rise Time	The time it takes for the device to change from EPAP to IPAP. You can adjust this time for your comfort.
Standby State	The state of the device when the device is on, but the airflow is off.

3.2 WHAT IS BI-LEVEL VENTILATION?

Bi-level ventilation with the BiPAP autoSV device helps you to breathe by supplying two levels of air pressure. The device provides a higher pressure—known as IPAP (Inspiratory Positive Airway Pressure)—when you inhale, and a lower pressure—known as EPAP (Expiratory Positive Airway Pressure)—when you exhale. The higher pressure makes it easier for you to inhale, and the lower pressure makes it easier for you to exhale.

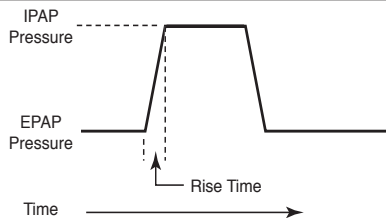

Figure 3-1 IPAP and EPAP Breathing Levels

You can adjust the Rise Time to make the pressure change more comfortable.

3.3 WHAT IS THE BiPAP autoSV DEVICE?

The device, shown in Figure 3-2, supplies air pressure through a breathing circuit.

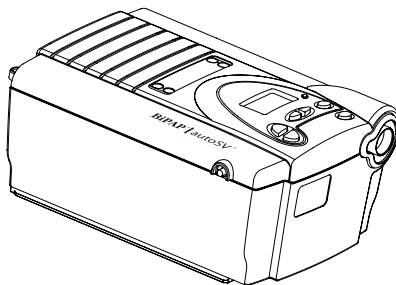

Figure 3-2 The BiPAP autoSV Device

A breathing circuit, shown in Figure 3-3, consists of:

- Circuit tubing to deliver air from the device to your interface (e.g., mask)
- A mask or other patient interface device to deliver the prescribed pressure to your nose or nose and mouth, depending on which interface has been prescribed for you
- An exhalation device to vent exhaled air from the circuit

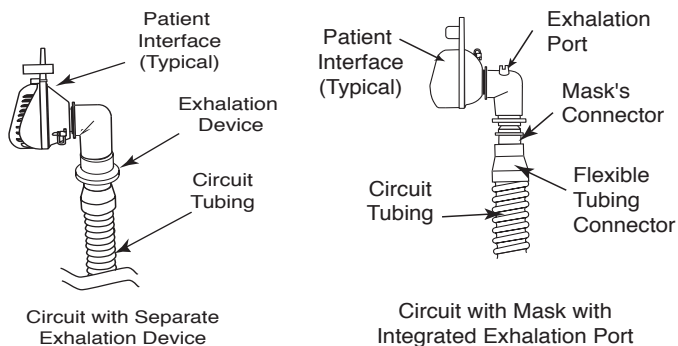

Figure 3-3 Two Typical Breathing Circuits

NOTE: The exhalation port may be part of the mask or may be part of a separate exhalation device, but is required to minimize the potential for CO₂ rebreathing.











The system senses your breathing effort and changes pressure levels when you inhale and exhale depending on the mode of operation.

WARNING: The device can operate on AC or DC power. The DC power option is not intended as a battery backup.

CAUTION: When DC power is obtained from a vehicle battery, the device should not be used while the vehicle's engine is running.

3.4 SYMBOLS

The symbols shown below are used on the device, the AC power supply, and throughout this manual.

Symbol	Meaning
	Attention, consult accompanying documents
	DC Power
	Pressure On/Off
	Type BF Applied Part
	Class II (Double Insulated)
	European CE Declaration of Conformity
	Canadian/US Certification
	Electrostatic Discharge
IPX1	Drip Proof Equipment
	UL Recognized for Canada and the United States
	TUV Safety Standard Compliance
	No User Serviceable Parts

3.5 HOW TO CONTACT RESPIRONICS

To have your device serviced, contact your health care professional. If you need to contact Respirationics directly, call the Respirationics Customer Service department at 1-724-387-4000 or 1-800-345-6443. You can also use the following address:

Respirationics
1001 Murry Ridge Lane
Murrysville, PA 15668

Visit Respirationics web site at: www.respirationics.com

CHAPTER 4: DEVICE CONTROLS AND DISPLAY FEATURES

Figure 4–1 shows the location of the device’s alarm power indicators, control panel, **Pressure On/Off** button, and the breathing circuit connection.

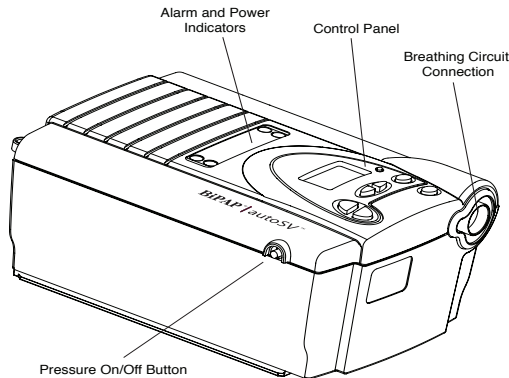



Figure 4–1 Device Front and Top

4.1 PRESSURE ON/OFF BUTTON

The device’s Pressure On/Off  button, located on the side of the device, starts and stops the device’s airflow.

- To turn the airflow on, press the button in, as shown in Figure 4–2. This puts the device in the **Operate** state.
- To turn the airflow off, press the button again. This puts the device in the **Standby** state.



Figure 4–2 Pressure Button On/Off Positions

When the device is in Standby, any ramp in progress is terminated, the alarms are reset (except for the System Errors alarm), and the humidifier is turned off.

The  button is independent of the display screen.

4.2 CONTROL PANEL

The control panel contains the following control buttons and indicators.

4.2.1 CONTROL BUTTONS

The control buttons on the control panel are shown in Figure 4–3.

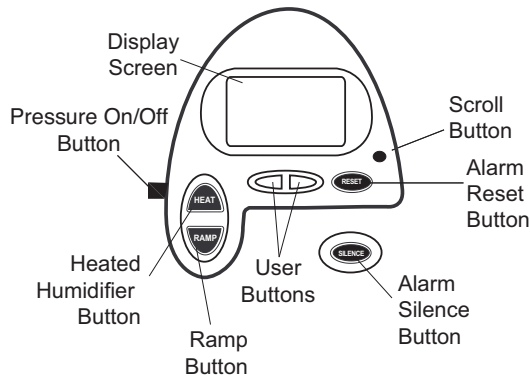

Figure 4–3 Control Panel

- HEAT** When the optional REMstar Heated Humidifier has been prescribed, this button controls the humidifier's output. Follow the instructions included with the humidifier. You can also use this button to adjust the settings shown in the user menu screens.
- RAMP** When the airflow is turned on and the ramp function is enabled, this button lowers the airflow pressure, allowing you to fall asleep more easily. You can also use this button to adjust the settings shown in the user menu screens.
- User** Press the left and right user buttons to navigate the user menu screens.
- SILENCE** This button silences the audible portion of an alarm for one minute. You can also use this button to exit the user menu screens.
- RESET** This button allows you to clear an alarm and reset the device for alarm detection.
- Use this button to scroll through the monitoring parameters.

4.2.2 ALARM AND POWER INDICATORS

Figure 4–4 shows the device's alarm and power indicators.

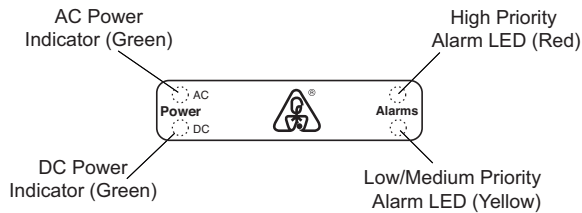

Figure 4–4 Alarm and Power Indicators

AC Power Indicator	The <i>green</i> AC Power LED lights up when the device is connected to AC Power.
DC Power Indicator	The <i>green</i> DC Power LED lights up when the device is connected to DC power.
High Priority Alarm Indicator	The <i>red</i> High Priority Alarm LED lights up when a high priority alarm occurs.
Low/Medium Priority Alarm Indicator	The <i>yellow</i> Low/Medium Alarm LED lights up when a medium or low priority alarm occurs.

NOTE: All LED indicators temporarily turn on when the device is first plugged in.

4.2.3 DISPLAY SCREEN

The display shows you the measured pressure and displays alarm messages. A backlight activates when any of the buttons are pressed and remains on until there are no buttons pressed for one minute.

Figure 4–5 shows the display screen.

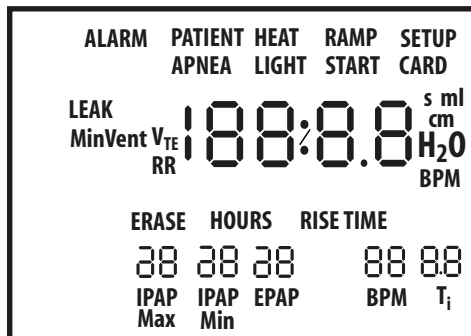

Figure 4–5 Display Screen

The information shown on the display screen is defined as follows:

ALARM	Indicates that the device requires user attention as indicated on the screen.
APNEA	Indicates that an apnea alarm has occurred.
BPM	Indicates that a breath rate setting is being displayed. This symbol flashes when the device is providing timed backup breaths.
CARD	Indicates that a SmartCard is inserted and detected.
cm H₂O	Indicates that the alphanumeric digits are displaying a pressure value.
EPAP	Indicates that an EPAP pressure setting is being displayed.
HEAT	Indicates that the humidifier is turned on and/or its setting is displayed.
LEAK	Indicates that the Estimated Leak Rate is being displayed.
LPM	Indicates that the value displayed is in liters per minute.
MinVent	Indicates that the Estimated Minute Ventilation is being displayed.
ml	Indicates that the value displayed is in milliliters.
HOURS	Indicates that the Therapy Hour Meter is being displayed.
T_i	Indicates that an inspiratory time setting is being displayed.
IPAP Max	Indicates that an IPAP <i>maximum</i> pressure setting is being displayed.
IPAP Min	Indicates that an IPAP <i>minimum</i> pressure setting is being displayed.
LIGHT	Indicates that the control pad LED backlight setting is being displayed or is active.
PATIENT	Indicates that a Patient Disconnect alarm is active.
RAMP	Indicates that the Ramp function is in progress.
RAMP START	Indicates that the Ramp Starting Pressure is being displayed.
RISE TIME	Indicates that a rise time setting is being displayed.
RR	Indicates that the Respiratory Rate (RR) is being displayed.
s	The small “s” on the right side of the display (above “cm H ₂ O”) indicates that the alphanumeric digits are displaying a time value, in seconds.
V_{TE}	Indicates that the Estimated Exhaled Tidal Volume is being displayed.

4.2.4 BREATHING CIRCUIT CONNECTION

Figure 4–6 shows where the circuit tubing connects to the device.

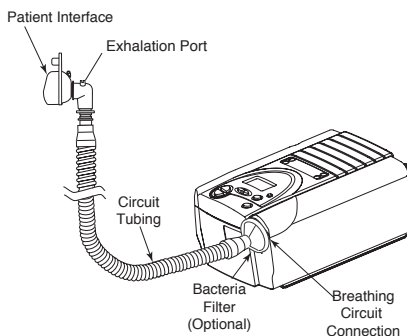

Figure 4–6 Typical Breathing Circuit Connection

4.2.5 REAR PANEL

Figure 4–7 shows the device's rear panel.

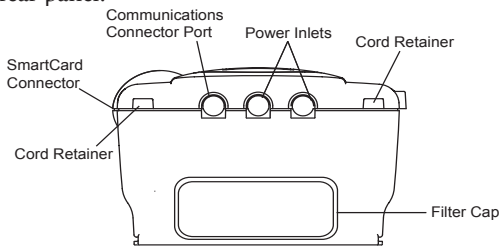

Figure 4–7 Rear Panel

NOTE: The SmartCard Connector is located on the side of the device.

WARNING: In order to ensure proper protection against electrical shock, only communications accessories with an IEC 60601-1 approved power supply may be connected through the SleepLink interface. All IEC 950 devices must only be connected to the 7-pin connector with the Respirationics Isolation cable (Part Number 1012865).

The rear panel contains the following:

Communications Connector	This connector accepts the Respirationics Communications cable for computer and external communications or a remote alarm. (Use only with an IEC 60950 approved computer.)
Power Inlets	There are two power inlets on the rear panel, one for connecting the external AC power supply and another for connecting the external DC power adapter.
Filter Cap	The filter cap can be removed to inspect the inlet air filters.
Cord Retainers	Two cord retainers are located on the rear panel to provide strain relief for the power cord.

CHAPTER 5: SETTING UP THE BiPAP AUTO_{SV} DEVICE

5.1 INSTALLING THE AIR FILTERS

The device uses one or two removable filters at the air inlet. The disposable white ultra-fine filter is optional. You must install the gray foam filter before operating the device. The foam filter is washable and reusable.

CAUTION: A properly installed, undamaged foam filter is required for proper operation.

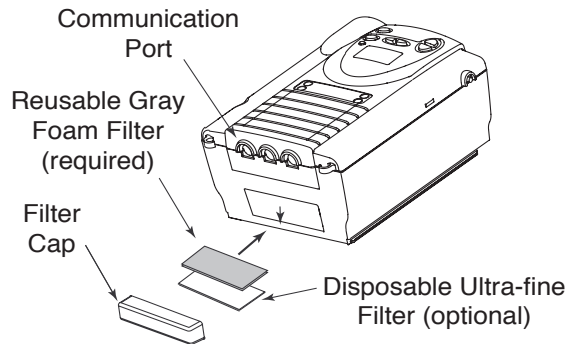

Figure 5-1 Installing the Air Filters

To install the air filters, complete the following steps:

1. If you are using the optional white ultra-fine filter, place it against the gray foam filter so the soft side of the ultra-fine filter touches the gray foam filter. When the filters are installed, the hard plastic side of the white filter will touch the inside of the device.
2. Slide the filters into the air inlet at the rear of the device (with the white filter going in first, if it's used). Push them down into the recess as shown in Figure 5-1.
3. Position the cap so that the small opening on the cap is facing down.
4. Snap the cap into place.

NOTE: The filter cap should be installed with the air inlet opening at the bottom.

See Chapter 9 for information about cleaning or replacing the filters.

5.2 WHERE TO PLACE THE DEVICE

Place the device on its base somewhere within easy reach of where you will use it. Make sure that the air inlet on the rear of the device is not blocked. Place the device on a hard, flat surface. If you block the air flow around the device, the device may not work properly.

WARNING: Position the humidifier so the water level is lower than you, and the humidifier is on the same level or lower than the device. See the humidifier instructions for complete setup information.

5.3 CONNECTING THE BREATHING CIRCUIT

To connect your breathing circuit to the device, complete the following steps:

1. Connect one end of the circuit tubing to the outlet of the bacteria filter (if using one) and connect the inlet of the bacteria filter to the large connector on the device as shown in Figure 5–2.

If you are not using a bacteria filter, connect the end of the circuit tubing directly to the outlet connector on the device.

NOTE: Follow the recommendations of your health care professional for using the optional bacteria filter.

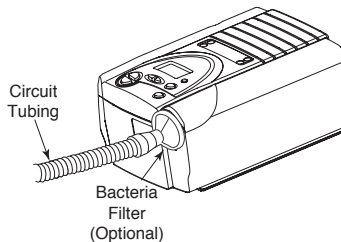

Figure 5–2 Connecting the Tubing to the Outlet

2. Connect the tubing to the mask:
 - A. If you are using a mask with a built-in exhalation port, connect the mask's connector to the circuit tubing, as shown in Figure 5–3.

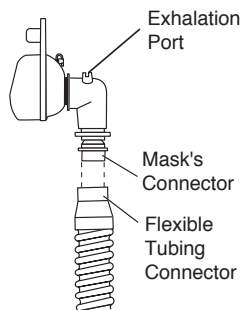

Figure 5–3 Connecting a Mask with a Built-In Exhalation Port

- B. If you are using a mask with a separate exhalation device, connect the open end of the circuit tubing to the exhalation device as shown in Figure 5–4. Position the exhalation device so that the vented air is blowing away from your face.

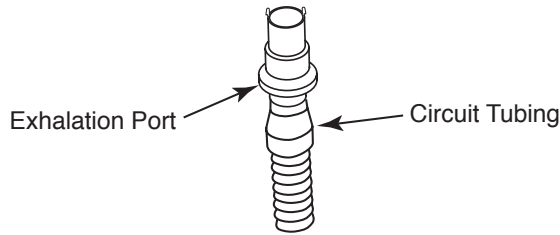

Figure 5–4 Connecting a Exhalation Device

Connect the mask's connector to the exhalation device, as shown in Figure 5–5. See the mask instructions for complete setup information.

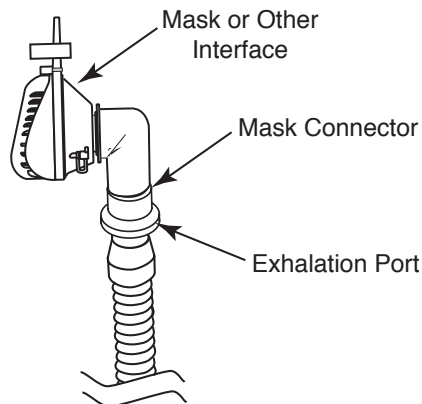

Figure 5–5 Connecting the Mask

WARNING: The exhalation device is designed to exhaust CO₂ from the patient circuit. Do not block or seal the ports on the exhalation device.

3. Attach the headgear to the mask. See the instructions that came with your headgear.

5.4 COMPLETE SETUP

Figure 5–6 shows the completed breathing circuit setup.

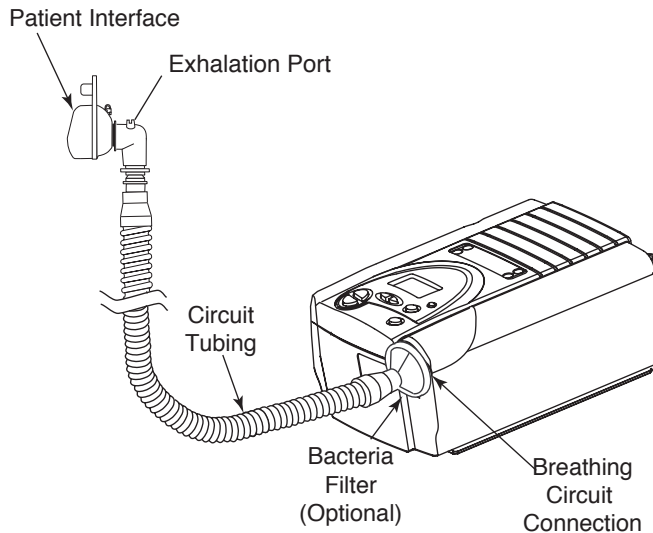

Figure 5–6 Complete Breathing Circuit

5.5 PLUGGING THE DEVICE IN

You can use AC or DC power to operate the BiPAP autoSV device.

WARNING: The DC power option is not intended as a battery backup when using AC power.

WARNING: For proper use, the power supply **must** be placed feet down, in the upright position, as shown in Figure 5–7.

5.5.1 USING AC POWER

Complete the following steps to operate the BiPAP autoSV device using AC power:

1. Plug the pronged end of the AC power supply's cord into an electrical outlet.
2. The external AC power supply features a cord retainer to provide strain relief for the AC power cord. Wrap the cord around the AC power supply's cord retainer, using the wire tie supplied with your power supply.

WARNING: Never plug the AC power supply into an outlet that is controlled by a wall switch.

WARNING: Route the wires to avoid tripping.

3. Leaving a small amount of slack in the cord, connect the cord on the other side of the power supply to one of the power inlets on the device, as shown in Figure 5–7. The power cord has a locking connector. To properly plug the cord in:
 - a. Pull the locking mechanism back.
 - b. Push the connector into place.
 - c. Release the lock.

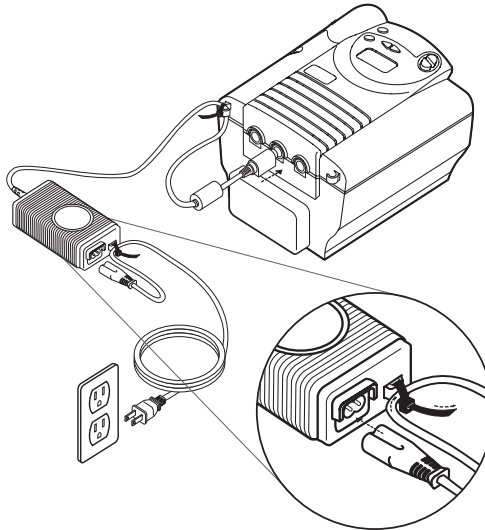

Figure 5–7 Plugging in the AC Power Supply

NOTE: You can plug the cord into either of the power inlets on the back of the device.

4. Wrap the cord around the device's power cord retainer, which provides strain relief for the power cord.
5. Ensure that all connections are secure.

NOTE: If you need to disconnect the power cord from the device, slide the locking connector back and then remove the power cord.

5.5.2 USING DC POWER

You can operate the BiPAP autoSV device on DC power by using the Respironics DC power adapter accessory. See the DC power adapter instructions for more information.

CAUTION: Use only the Respironics DC power adapter available from your health care professional. Using any other system may cause damage to the BiPAP autoSV device or the vehicle.

CAUTION: When using DC power from a vehicle battery, the BiPAP autoSV device should not be used while the vehicle's engine is running. Damage to the device or the vehicle may occur.

CHAPTER 6: OPERATING THE DEVICE

6.1 STARTING THE DEVICE

1. Plug in the device to an AC or DC power source to power up the device. A confirmation alarm sounds, and the control pad buttons light up.

NOTE: If the alarm does not sound or the buttons do not light up, the device requires servicing. Call your health care professional.

Several screens appear initially during this step:

- a. The first screen that appears is the Self Test screen, shown in Figure 6–1. This is the internal test performed by the device.

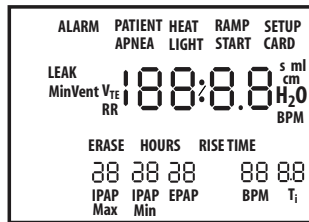

Figure 6–1 Self Test Screen

- b. The next screen displays the software version, as shown in Figure 6–2:

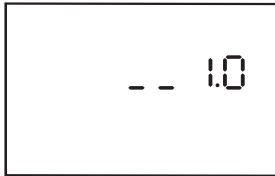

Figure 6–2 Software Version Screen

NOTE: The version number (1.0) shown in Figure 6–2 is an example. Your device may have a higher software version installed.

- c. The third screen to appear is the Blower Hours screen, which displays the blower hours time meter:

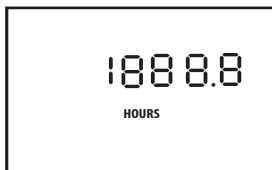



Figure 6–3 Blower Hours Screen

NOTE: With the exception of the  button, the control pad is inactive during these first three screens. Each of these screens appears for approximately 1-3 seconds.

- d. The next screen that appears is the Standby screen, shown in Figure 6–4. This indicates that the device is in the Standby state (the blower is off).

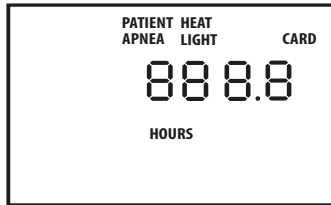



Figure 6–4 Standby Screen

2. Press the  button to put the device into the Operate state (and turn on the airflow). The Monitoring screen, shown in Figure 6–5, appears.

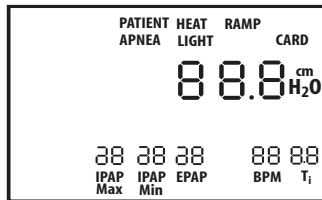

Figure 6–5 Monitoring Screen

Both the Monitoring and the Standby screens display **PATIENT**, **APNEA**, **LIGHT**, and **HEAT** if these features are enabled. Additionally, **CARD** displays if a SmartCard is inserted.

The Monitoring screen displays **RAMP**, if ramp is enabled and the **RAMP** button has been pressed. If fixed timed backup rate is prescribed, **BPM** and T_i will be displayed if the health care professional set the breath rate between 4-30 BPM.

3. Put on your mask assembly when the air starts to flow.
4. Make sure that no air is leaking from your mask into your eyes. If it is, adjust the mask and headgear until the air leak stops. See the instructions that came with your mask for more information.

NOTE: A small amount of mask leak is normal and acceptable. Correct large mask leaks or eye irritation from an air leak as soon as possible.

5. If you are using the device while sleeping, try placing the tubing from the device over your headboard. This may reduce tension on the mask.
6. Relax. Take normal, relaxed breaths through your nose.

NOTE: If you are having trouble with your mask, see Chapter 8, *Troubleshooting*, for some suggestions.

6.2 CHANGING THE DEVICE SETTINGS

You can view the following settings and indicators on the display screen:

- Measured pressure
- Backlight settings
- Humidifier, SmartCard and Ramp status
- Patient alarms
- Measured parameters (Leak, Respiratory Rate, Minute Ventilation, Exhaled Tidal Volume)

Additionally, you can view and modify the following settings using the display screens:

- Humidifier heat
- Rise Time
- Ramp start pressure
- LED backlight

NOTE: When changing any setting (except for the Ramp Start Pressure setting), once a maximum setting is reached, the setting rolls back over to the minimum setting, and likewise, once a minimum setting is reached, it rolls back over to the maximum setting provided.

For example, the minimum humidifier setting is **1** and the maximum is **5**. Once the humidifier setting is increased to **5**, if you press the **HEAT** button again, the setting will go back to **1**. Or, once the humidifier setting is decreased to **1**, if you press the **RAMP** button again, the setting will go back to **5**.

6.2.1 CHANGING THE HUMIDIFIER SETTING

If you are using the REMstar Heated Humidifier with your device, you can adjust the humidifier heat setting by completing the following steps:

1. From either the Standby or Monitoring screen, press and hold the **HEAT** button for several seconds. The Humidifier Setting screen appears, as shown in Figure 6–6.

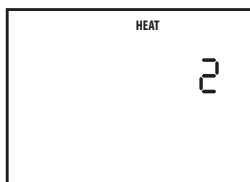

Figure 6–6 Humidifier Setting Screen

2. Press the **HEAT** button to increase the humidifier setting, or press the **RAMP** button to decrease the setting. You can adjust the setting from 1 to 5. The change takes effect immediately as you adjust the setting.

- You can exit this screen by pressing the Left or Right User buttons or the **SILENCE** button.

For additional information on using a humidifier with the device, see Chapter 10.

- To turn the humidifier ON/OFF, press the **HEAT** button until the device beeps twice and the text **HEAT** appears/disappears.

6.2.2 NAVIGATING THE USER DISPLAY SCREENS

You can navigate the rest of the user display screens by pressing the **Left** and **Right User** keys.

You can change the settings on any of the display screens by pressing the **HEAT** and **RAMP** buttons to increase or decrease the setting.

You can exit any of the user display screens by pressing the **SILENCE** button.

Figure 6–7 shows how to navigate the user display screens using the right and left user buttons.

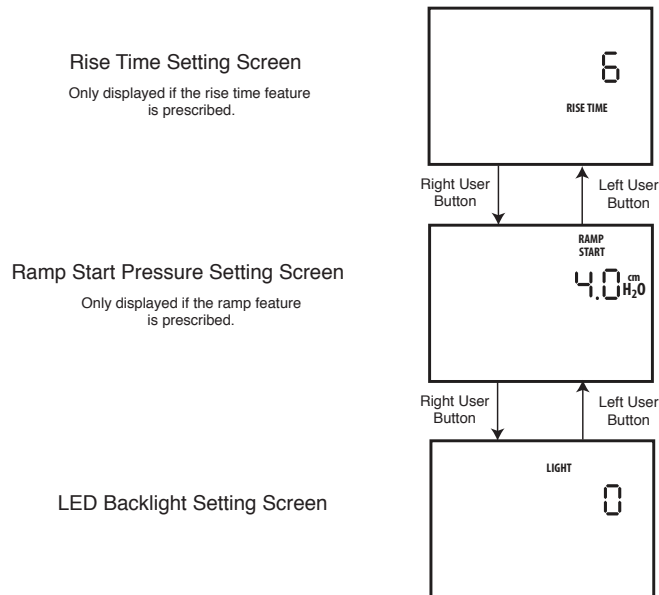

Figure 6–7 Navigating the User Display Screens

6.2.2.1 CHANGING THE RISE TIME SETTING

Rise time is the time it takes for the device to change from EPAP to IPAP. You can adjust the rise time to find the setting that provides you with the most comfort.

NOTE: If the screen shown in Figure 6–8 does not display, you cannot adjust this setting.

To change the rise time setting, complete the following steps:

1. From either the Monitoring or Standby screens, press the Right User button until you reach this screen. The Rise Time Setting screen is shown in Figure 6–8.



Figure 6–8 Rise Time Setting Screen

2. Increase or decrease the rise time setting from 1 to 6 by pressing the **HEAT** or **RAMP** button until you find the right setting. A setting of 1 is the fastest rise time, while 6 is the slowest.

6.2.2.2 CHANGING THE RAMP STARTING PRESSURE

The device is equipped with an optional ramp feature. This feature will reduce the pressure and then gradually increase (ramp) the pressure to the prescription pressure setting so you can fall asleep more comfortably.

NOTE: The ramp feature is not prescribed for all users. If the screen shown in Figure 6–9 does not appear on your display, you cannot adjust this setting.

To change the ramp starting pressure setting, complete the following steps:

1. From either the Monitoring or Standby screens, press the Right User button until the Ramp Start Setting screen appears, as shown in Figure 6–9.



Figure 6–9 Ramp Start Setting Screen

2. Press the **HEAT** or **RAMP** button to increase or decrease the ramp starting pressure as needed. You can adjust the setting from 4.0 cm H₂O to your EPAP setting.

6.2.2.3 CHANGING THE LED BACKLIGHT SETTING

When airflow is turned on and the device is in the Operate state, you can turn the control pad lighting behind the buttons on or off using the LED backlight setting.

NOTE: The lights are always on when the airflow is off and the device is in Standby.

To change the LED backlight setting, complete the following steps:

- From either the Monitoring or Standby screens, press the Right User button until the LED Backlight Setting screen appears, as shown in Figure 6–10.

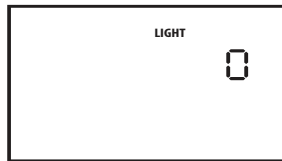

Figure 6–10 LED Backlight Setting Screen

- Press the **HEAT** or **RAMP** button to select a new setting. A setting of 1 means the light is on, while 0 means the light is off.

6.3 MONITORING MEASURED PARAMETERS

You can view four measured parameters—leak, respiratory rate, minute ventilation, and exhaled tidal volume. To access these screens from the Monitoring or Standby screens, press the small circular Scroll button (●) located near the **RESET** button.

Figure 6–11 shows how to navigate the measured parameter screens.

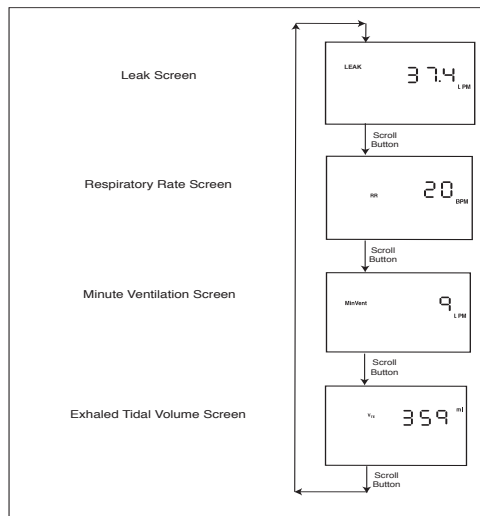

Figure 6–11 Measured Parameter Screen Navigation

To return to the Monitoring or Standby Screen from these Measured Parameter screens, press the **SILENCE** button.

NOTE: If you view these screens from the Standby screen, each of these screens will display a value of zero, because no therapy is being delivered.

1. Leak Screen

This screen, shown in Figure 6–12, shows the average of the leak values for the previous six breaths.



Figure 6–12 Leak Screen

2. Respiratory Rate Screen

This screen, shown in Figure 6–13, shows the average rate of respiration for the previous six breaths.



Figure 6–13 Respiratory Rate Screen

3. Minute Ventilation Screen

This screen, shown in Figure 6–14, shows the estimated Exhaled Minute Ventilation (the volume of air received on a per minute basis) based on the average of the previous six breaths.



Figure 6–14 Minute Ventilation Screen

NOTE: The value shown for Exhaled Minute Ventilation is an estimate.

4. Exhaled Tidal Volume Screen

This screen, shown in Figure 6–15, shows the estimated Exhaled Tidal Volume, which is the volume of each breath.



Figure 6–15 Exhaled Tidal Volume Screen

NOTE: The value shown for Exhaled Tidal Volume is an estimate.

CHAPTER 7: ALARMS

7.1 INTRODUCTION TO ALARMS

The device provides three alarm levels: high, medium, and low priority.

High Priority These alarms require *immediate response*. The alarm signal consists of a red LED indicator and a sound that is either a periodic pattern consisting of a two-second beep followed by two seconds of silence or a pattern of three beeps, a pause, and then two more beeps. The display has **ALARM** at the top of the screen. The tables in Section 7.3 display these sounds using the following symbols: ••• •• or ■■■ ■■■

Medium Priority These alarms require *prompt response*. The alarm signal consists of a yellow LED and a sound that repeats a pattern of three beeps. The display has **ALARM** at the top of the screen. The tables in Section 7.3 display these sounds using the following symbols: •••

Low Priority These alarms require your *awareness*. The alarm signal consists of a yellow LED and a sound that repeats a pattern of two beeps. The display has **ALARM** at the top of the screen. The tables in Section 7.3 display these sounds using the following symbols: ••

Some audible alarms are self-cancellable. This means that the alarm sound stops when the cause of the alarm is corrected.

The alarm LED indicators are shown in Figure 7-1.

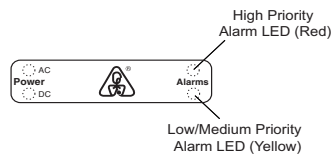

Figure 7-1 Alarm LED Indicators

In addition to the alarm LED indicators, the control panel also contains **Alarm Reset** and **Alarm Silence** buttons, as shown in Figure 7-2.

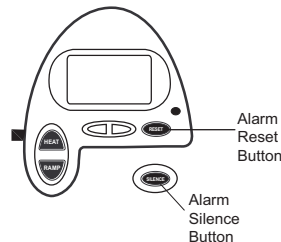

Figure 7-2 Alarm Buttons

7.2 WHAT TO DO WHEN AN ALARM OCCURS

The following example applies to most alarm conditions. Follow these steps unless otherwise directed by the alarm tables that follow.

1. Look at the alarm indicators and listen to the alarm sound.



Figure 7-3 Alarm LED Lights Up

Note the color of the LED and whether the LED is solid or flashing.

2. Look at the display for text.

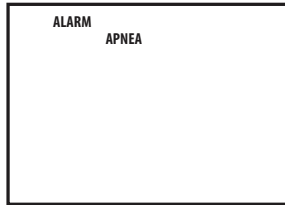

Figure 7-4 Sample Alarm Display

ALARM appears at the top of the screen to indicate an alarm. Additional codes and symbols may also appear depending on the type of alarm.

3. Press the **SILENCE** button to temporarily silence the alarm (for one minute). The display returns to the screen that was showing when the alarm occurred.
4. Look up the alarm in the alarm tables shown in Section 7.3 and perform the action specified.
5. Press the **RESET** button to clear the alarm.

7.3 ALARM TABLES

The following tables summarize the high priority, medium priority, and low priority alarms.

7.3.1 HIGH PRIORITY ALARMS

Alarm LED	Alarm Sound	Display Message	Device Action	Possible Cause	Your Action
Red Flash	• • • • •	ALARM and PATIENT flash	Operates	Breathing circuit is disconnected or has a large leak.	Press the RESET button to reset the alarm. Reconnect the circuit or fix the leak.
Red Flash	• • • • •	ALARM and APNEA flash	Operates	An apnea event occurred during therapy.	Press the RESET button to reset the alarm. Continue using the device. Report the alarm to your health care professional.
Red Flash	• • • • •	ALARM and MinVent flash	Operates	A low minute ventilation event occurred during therapy.	Press the RESET button to reset the alarm. Continue using the device. Report the alarm to your health care professional.
Red Flash	• • • • •	ALARM flashes and an error code ("Exx") displays	Shuts down. Blower cannot be restarted.	Device failure	Press the RESET button to reset the alarm. Remove power from the unit. Restore power. If the alarm continues, contact your health care professional.
Red Flash	• • • • •	ALARM and cm H₂O flash	Operates	Excessive leak or blockage; malfunctioning unit.	Press the RESET button to reset the alarm. Check for the following: dirty inlet filters, blocked air intake, excessive leak in the circuit. If the alarm continues, call your health care professional.
Red Solid	■ ■	Blank screen	Shuts down	Battery is discharged. -or- Power was lost while the unit was providing therapy.	Press the  button to silence the alarm. Remove the DC power source from the unit. Replace the battery and restore power to the unit. Or, seek a reliable AC power source. Restore power. If the alarm continues, call your health care professional.

7.3.2 MEDIUM PRIORITY ALARMS

Alarm LED	Alarm Sound	Display Message	Device Action	Possible Cause	Your Action
Yellow Flash DC Power LED Flashes	• • •		Operates	Battery is nearly discharged.	Press the RESET button to reset the alarm. Replace the battery. If the alarm continues, contact your health care professional.

7.3.3 LOW PRIORITY ALARMS

Alarm LED	Alarm Sound	Display Message	Device Action	Possible Cause	Your Action
Yellow Solid	• •	CARD flashes and card error code ("Cxx") displays	Operates	There is a problem with the SmartCard inserted in the SmartCard connectivity slot. Perhaps the SmartCard is inserted upside down or backwards.	Confirm that the SmartCard is properly inserted. If the alarm continues to occur, remove the SmartCard from the device and contact your health care professional.
Yellow Solid DC power LED flashes	• •		Operates	The device lost AC power and is now operating on DC power. At start-up only, alarm notifies you that a battery is being used to provide power.	Press the RESET button to reset the alarm. Check the AC power. Seek a reliable power source. Provide AC power if you do not want to use a battery; otherwise, no further action is needed.
Yellow Solid AC power LED flashes	• •	Unchanged	Operates	The AC power supply is out of spec (<22V) or there is a defective battery sense line on the DC power adapter.	Remove power from the device and then restore power. If alarm continues to occur, contact your health care professional.
Yellow Solid	• •	ALARM, CARD and cm H₂O flash	Operates	The device has successfully downloaded the prescription from the SmartCard.	Remove the SmartCard from the device. If alarm continues to occur, contact your health care professional.

CHAPTER 8: TROUBLESHOOTING

This chapter describes problems that you may experience with your BiPAP autoSV device or mask and provides possible solutions.

Problem	Why It Happened	What To Do
The device does not operate when you press the  button.	If the power LED is off, there's no power at the outlet or the device is unplugged. If the power LED is on, the problem is in the device.	Check the outlet power and verify that the device is plugged in. If the problem continues, call your health care professional.
The air out of the mask is much warmer than usual.	The inlet filters may be dirty. The device may be operating in direct sunlight or near a heater.	Clean or replace the inlet air filters as described in Chapter 9. Make sure the device is away from bedding or curtains that could block the flow of air around the device. Make sure the device is away from direct sunlight and heating equipment. If the problem persists, contact your health care professional.
The mask feels uncomfortable to wear.	This could be due to improper headgear adjustment or improper mask fitting.	Check the headgear adjustment as described in the headgear instructions. Refer to your mask instructions to make sure the mask is properly fitted. If the problem continues, contact your health care professional for a refitting or a different size mask.
There is significant air leakage round the mask.	This could be due to improper headgear adjustment or improper mask fitting.	Check the headgear adjustment as described in the headgear instructions. Refer to your mask instructions to make sure the mask is properly fitted. If the problem continues, contact your health care professional for a refitting or a different size mask.

Problem	Why It Happened	What To Do
Redness occurs when the mask cushion comes in contact with the skin.	This could be due to improper mask fitting or improper mask cleaning.	Be sure to rinse the mask thoroughly after cleaning to remove residue. See the mask cleaning instructions for detailed information. If the problem continues, contact your health care professional for a refitting or a different size mask.
Redness occurs when the mask cushion accessory comes in contact with the skin.	Irritation or allergic reaction to the mask material.	Use a barrier between your skin and the mask, such as 3M's Microfoam [®] or Squibb's Duoderm [®] . Refer to your mask instructions for additional information.
Sore or dry eyes.	The mask may not be positioned correctly, or the mask is not properly fitted.	Check the headgear adjustment as described in the headgear instructions. Refer to your mask instructions to make sure the mask is properly fitted. If the problem continues, contact your health care professional for a refitting or a different size mask.
There are unexplained changes in the performance of the device.	The device or power supply has been dropped or mishandled, or water has been spilled onto or into the device or the power supply.	Discontinue use. Contact your health care professional or Respirationics for directions on how to have your device serviced. Please have the serial number ready when you call.
A patient disconnect alarm occurs.	The tubing has become disconnected from the system.	Press the RESET button to reset the alarm. Reconnect the tubing. If the alarm continues, the device may not be operating correctly. Contact your health care professional or Respirationics for directions on having the device serviced. Please have your serial number ready when you call.
Runny nose.	Nasal reaction to the air flow.	Call your health care professional.

Problem	Why It Happened	What To Do
The device's display is erratic.	The device or power supply has been dropped or mishandled, or the device or power supply is in an area with high EMI emissions.	Unplug the device and the power supply. Relocate the device to an area with lower EMI emissions.
A SmartCard error occurs.	The SmartCard is not inserted properly. It may be inserted upside down or backwards.	Remove the SmartCard and reinsert it so that the printed side of the card is facing up and the end with the arrow goes into the device first. If the error message appears again, contact your health care professional or Respirationics for directions on having your device serviced. Please have your serial number ready when you call.

CHAPTER 9: CLEANING AND MAINTENANCE

9.1 CLEANING THE DEVICE

Before cleaning or performing any routine maintenance, always make sure the device is not operating and disconnect the device from the power source.

NOTE: The following cleaning instructions are for the BiPAP autoSV device only. To clean the accessories, refer to each accessory's instruction sheet.

CAUTION: Do not immerse the device or allow any liquid to enter the enclosure, inlet filter, or any openings.

Clean the front panel and exterior of the enclosure as needed using a cloth dampened with water and a mild detergent. Allow the device to dry completely before plugging in the power cord.

Gently wash the reusable circuit tubing in a solution of warm water and a mild detergent. Rinse thoroughly and allow to air dry.

9.2 CLEANING OR REPLACING THE INLET FILTERS

The device has two removable filters at the air inlet. The gray foam filter is washable and reusable. The optional white, ultra-fine filter is disposable. The gray foam filter should be cleaned at least once every two weeks under normal usage and replaced with a new one every six months. The white ultra-fine filter is disposable and should be replaced after 30 nights of use or sooner if it appears dirty. **Do not** attempt to clean the ultra-fine filter because this will damage the filter.

NOTE: Dirty inlet filters may cause high operating temperatures and may affect performance. Regularly examine the inlet filters as needed for integrity and cleanliness.

1. Make sure the device is not operating, and disconnect the power cord from the wall outlet or DC source.
2. As shown in Figure 9–1, remove the filter cap by gently pressing in on the sides of the filter cover and pulling the cap out, away from the device.

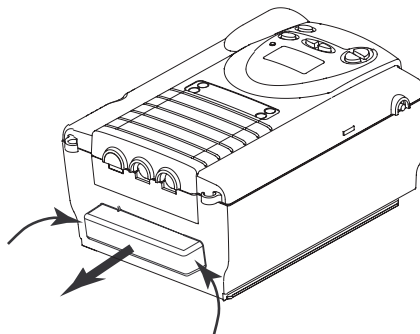

Figure 9–1 Removing the Filter Cover

- Remove the filters from the enclosure by gently pulling around the edges of the filters. The top filter is the reusable gray foam filter. The bottom filter is the optional disposable white ultra-fine filter, as shown in Figure 9–2.

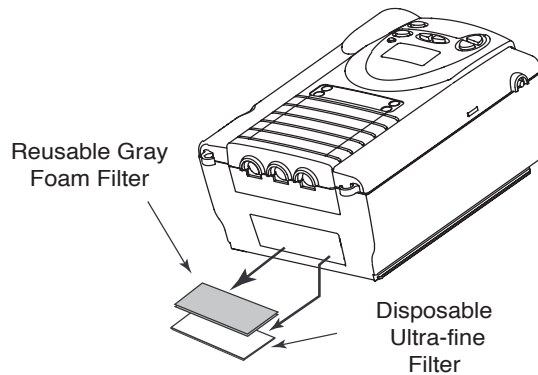

Figure 9–2 Removing the Filters

- Examine the filters regularly for cleanliness and integrity.
- If needed, wash the gray foam filter in warm water with a mild detergent. Rinse thoroughly to remove all detergent residue. Allow the filter to dry completely before reinstalling it. If the foam filter is torn, replace it. (Only Respironics-supplied filters should be used as replacement filters.)

CAUTION: Never install a wet filter into the device. It is recommended that you clean the filter in the morning and alternate using the two gray foam filters provided with the system to ensure sufficient drying time for the cleaned filter.

- If the ultra-fine filter is dirty or torn, replace it.
- Reinstall the filters. If you are using the optional white ultra-fine filter, place it against the gray foam filter so the soft side of the ultra-fine filter touches the gray foam filter. Slide the filters into the air inlet at the rear of the device and push them into the recess. When the filters are installed, the hard plastic side of the white filter will touch the inside of the device.
- Reinstall the filter cover. Contact your health care professional to order additional filters.

9.3 CARRYING CASE

A carrying case (reorder number: 1005965) is included with your BiPAP autoSV system. The case is designed to hold your device, along with your circuit accessories and humidifier.

When you are travelling, the carrying case can be used for carry-on luggage only. The carrying case will not protect the device if it is put through checked baggage.

NOTE: If travelling with your humidifier, make sure you empty the water chamber before placing it in the carrying case.

CHAPTER 10: ACCESSORIES

10.1 ADDING A HUMIDIFIER

The REMstar Heated Humidifier, REMstar Passover Humidifier, and H2 Heated Humidifier are available from your health care professional. The humidifiers may reduce nasal dryness and irritation by adding moisture (and heat, if applicable) to the airflow.

CAUTION: For safe operation, the humidifier must always be positioned below the circuit connection at the mask and the air outlet on the device. The humidifier must be level for proper operation.

Refer to the humidifier instructions for complete setup information.

10.2 ADDING OXYGEN TO THE DEVICE

Oxygen may be added to the mask connection. Please note the warnings listed below when using oxygen with the device.

WARNING: If you are using oxygen, your device must be equipped with the Respironics Pressure Valve (Part number 302418). Failure to use the Pressure Valve could result in a fire hazard.

WARNING: Oxygen accelerates fires. Keep the device and the O₂ containers away from heat, open flames, any oily substance, or other sources of ignition. Do not smoke in the area near the device or the O₂ container.

WARNING: When using oxygen with your device, the oxygen supply must comply with the local regulations for medical oxygen.

WARNING: When using oxygen with this system, turn the device **on** before turning the oxygen on. Turn the oxygen **off** before turning the device off. This will prevent oxygen accumulation in the device.

CHAPTER 11: SPECIFICATIONS

ENVIRONMENTAL

	Operating	Storage
Temperature	41° F (5° C) to 95° F (35° C)	-4° F (-20° C) to 140° F (60° C)
Relative Humidity	15 to 95% (non-condensing)	15 to 95% (non-condensing)
Atmospheric Pressure (5600 feet to sea level)	83 to 102kPa	

PHYSICAL

Dimensions:	9.75 in. L x 6.625 in. W x 4.4 in. H (24.8 cm L x 16.8 cm W x 11.2 cm H)
Weight:	4 lbs (1.8 kg)

ELECTRICAL

AC Voltage Source:	100 to 240 VAC, 50/60 Hz
DC Voltage Source:	12 VDC (when operated with the external DC power adaptor accessory)
AC Current:	1.25 A maximum
DC Current:	3.0 A maximum
Protection against electric shock:	Class II
Degree of protection against electric shock:	Type BF Applied Part
Degree of protection against harmful ingress of water:	
BiPAP autoSV device:	Ordinary Equipment, IPX0
AC Power Supply (Reorder number 1012832):	Drip Proof, IPX1
DC Power Adapter (Reorder number 1012975):	Drip Proof, IPX1
Modes of Operation:	Continuous
Electromagnetic Compatibility:	The BiPAP autoSV device meets the requirements of EN 60601-1-2, second edition (2001).
Fuses:	There are no user-replaceable fuses.

PRESSURE

Output:	4 to 30 cm H ₂ O
----------------	-----------------------------

CONTROL ACCURACY

Parameter	Range	Accuracy
IPAP Min	4 to 30 cm H ₂ O	± 5 cm H ₂ O*
IPAP Max	4 to 30 cm H ₂ O	± 5 cm H ₂ O*
EPAP	4 to 25 cm H ₂ O	± 5 cm H ₂ O*
Breath Rate	4 to 30 BPM	Greater of ± 1 BPM or ± 10% of the setting (when measured over a 4 minute period)
Timed Inspiration	0.5 to 3.0 seconds	± (0.1 + 10% of the setting) seconds
Ramp Duration	0 to 45 minutes	± 10% of the setting
Rise Time	1 to 6 **	± 25%***
<p>* Dynamic pressure accuracy is ± 5 cm H₂O measured at the patient end of the circuit with a Whisper Swivel II and varying flow conditions. Static pressure accuracy is ± 2 cm H₂O measured at the patient end of the circuit with a Whisper Swivel II and no patient flow.</p> <p>** The range of values correspond to tenths of seconds (e.g., a setting of 4 indicates a Rise Time of 0.4 seconds).</p> <p>*** Measured at the patient end of circuit with a Whisper Swivel II exhalation device and no patient flow.</p>		

MEASURED PARAMETER ACCURACY

Parameter	Accuracy
Respiratory Rate	Greater of ±1 BPM or ±10% of reading when measured over a four minute period
Exhaled Tidal Volume	± (25 + 0.15 of reading) ml
Exhaled Minute Ventilation	± (1 + 0.15 of reading) L/min
Leak Rate	± (5 + 0.15 of reading) L/min

DISPOSAL

Dispose of this device in accordance with local regulations.

APPENDIX A: EMC INFORMATION

GUIDANCE AND MANUFACTURER'S DECLARATION - ELECTROMAGNETIC EMISSIONS: This device is intended for use in the electromagnetic environment specified below. The user of this device should make sure it is used in such an environment.

EMISSIONS TEST	COMPLIANCE	ELECTROMAGNETIC ENVIRONMENT - GUIDANCE
RF emissions CISPR 11	Group 1	The device uses RF energy only for its internal function. Therefore, its RF emissions are very low and are not likely to cause any interference in nearby electronic equipment.
RF emissions CISPR 11	Class B	
Harmonic emissions IEC 61000-3-2	Class A	
Voltage fluctuations/Flicker emissions IEC 61000-3-3	Complies	

GUIDANCE AND MANUFACTURER'S DECLARATION - ELECTROMAGNETIC IMMUNITY: This device is intended for use in the electromagnetic environment specified below. The user of this device should make sure it is used in such an environment.

IMMUNITY TEST	IEC 60601 TEST LEVEL	COMPLIANCE LEVEL	ELECTROMAGNETIC ENVIRONMENT - GUIDANCE
Electrostatic Discharge (ESD) IEC 61000-4-2	±6 kV contact ±8 kV air	±6 kV contact ±8 kV air	Floors should be wood, concrete or ceramic tile. If floors are covered with synthetic material, the relative humidity should be at least 30%.
Electrical Fast Transient/Burst IEC 61000-4-4	±2 kV for power supply lines ±1 kV for input-output lines	±2 kV for supply mains ±1 kV for input/output lines	Mains power quality should be that of a typical home or hospital environment.
Surge IEC 61000-4-5	±1 kV differential mode ±2 kV common mode	±1 kV differential mode ±2 kV for common mode	Mains power quality should be that of a typical home or hospital environment.
Voltage dips, short interruptions and voltage variations on power supply input lines IEC 61000-4-11	<5% U_T (>95% dip in U_T) for 0.5 cycle 40% U_T (60% dip in U_T) for 5 cycles 70% U_T (30% dip in U_T) for 25 cycles <5% U_T (>95% dip in U_T) for 5 sec	<5% U_T (>95% dip in U_T) for 0.5 cycle 40% U_T (60% dip in U_T) for 5 cycles 70% U_T (30% dip in U_T) for 25 cycles <5% U_T (>95% dip in U_T) for 5 sec	Mains power quality should be that of a typical home or hospital environment. If the user of the device requires continued operation during power mains interruptions, it is recommended that the device be powered from an uninterruptible power supply or a battery.
Power frequency (50/60 Hz) magnetic field IEC 61000-4-8	3 A/m	3 A/m	Power frequency magnetic fields should be at levels characteristic of a typical location in a typical hospital or home environment.
NOTE: U_T is the a.c. mains voltage prior to application of the test level.			

GUIDANCE AND MANUFACTURER’S DECLARATION - ELECTROMAGNETIC IMMUNITY: This device is intended for use in the electromagnetic environment specified below. The user of this device should make sure it is used in such an environment.

IMMUNITY TEST	IEC 60601 TEST LEVEL	COMPLIANCE LEVEL	ELECTROMAGNETIC ENVIRONMENT - GUIDANCE
Conducted RF IEC 61000-4-6	3 Vrms 150 kHz to 80 MHz	3 Vrms	Portable and mobile RF communications equipment should be used no closer to any part of the device, including cables, than the recommended separation distance calculated from the equation applicable to the frequency of the transmitter. Recommended separation distance: $d = 1.2 \sqrt{P}$ 150 kHz to 80 MHz $d = 1.2 \sqrt{P}$ 80 MHz to 800 MHz $d = 2.3 \sqrt{P}$ 800 MHz to 2.5 GHz Where P is the maximum output power rating of the transmitter in watts (W) according to the transmitter manufacturer and d is the recommended separation distance in meters (m). Field strengths from fixed RF transmitters, as determined by an electromagnetic site survey ^a , should be less than the compliance level in each frequency range ^b . Interference may occur in the vicinity of equipment marked with the following symbol: 
Radiated RF IEC 61000-4-3	3 V/m 80 MHz to 2.5 GHz	3 V/m	

NOTE 1: At 80 MHz and 800 MHz, the higher frequency range applies.
NOTE 2: These guidelines may not apply in all situations. Electromagnetic propagation is affected by absorption and reflection from structures, objects, and people.
a: Field strengths from fixed transmitters, such as base stations for radio (cellular/cordless) telephones and land mobile radios, amateur radio, AM and FM radio broadcast and TV broadcast cannot be predicted theoretically with accuracy. To assess the electromagnetic environment due to fixed RF transmitters, an electromagnetic site survey should be considered. If the measured field strength in the location in which the device is used exceeds the applicable RF compliance level above, the device should be observed to verify normal operation. If abnormal performance is observed, additional measures may be necessary, such as re-orienting or relocating the device.
b: Over the frequency range 150 kHz to 80 MHz, the field strengths should be less than 3 V/m.

RECOMMENDED SEPARATION DISTANCES BETWEEN PORTABLE AND MOBILE RF COMMUNICATIONS EQUIPMENT AND THIS DEVICE:

The device is intended for use in an electromagnetic environment in which radiated RF disturbances are controlled. The customer or the user of this device can help prevent electromagnetic interference by maintaining a minimum distance between portable and mobile RF communications equipment (transmitters) and this device as recommended below, according to the maximum output power of the communications equipment.

RATED MAXIMUM POWER OUTPUT OF TRANSMITTER (W)	SEPARATION DISTANCE ACCORDING TO FREQUENCY OF TRANSMITTER (m)		
	150 kHz to 80 MHz $d = 1.2 \sqrt{P}$	80 MHz to 800 MHz $d = 1.2 \sqrt{P}$	800 MHz to 2.5 GHz $d = 2.3 \sqrt{P}$
0.01	0.12	0.12	0.23
0.1	0.38	0.38	0.73
1	1.2	1.2	2.3
10	3.8	3.8	7.3
100	12	12	23

For transmitters rated at a maximum output power not listed above, the recommended separation distance *d* in meters (m) can be estimated using the equation applicable to the frequency of the transmitter, where P is the maximum output power rating of the transmitter in watts (W) according to the transmitter manufacturer.
Note 1: At 80 MHz and 800 MHz, the separation distance for the higher frequency range applies.
Note 2: These guidelines may not apply in all situations. Electromagnetic propagation is affected by absorption and reflection from structures, objects, and people.

LIMITED WARRANTY

Respironics, Inc. warrants that the BiPAP autoSV system shall be free from defects of workmanship and materials and will perform in accordance with the product specifications for a period of two (2) years from the date of sale by Respironics, Inc. to the dealer. If the product fails to perform in accordance with the product specifications, Respironics, Inc. will repair or replace – at its option – the defective material or part. Respironics, Inc. will pay customary freight charges from Respironics, Inc. to the dealer location only. This warranty does not cover damage caused by accident, misuse, abuse, alteration, and other defects not related to material or workmanship.

Respironics, Inc. disclaims all liability for economic loss, loss of profits, overhead, or consequential damages which may be claimed to arise from any sale or use of this product. Some states do not allow the exclusion or limitation of incidental or consequential damages, so the above limitation or exclusion may not apply to you.

This warranty is given in lieu of all other express warranties. In addition, any implied warranties – including any warranty of merchantability or fitness for the particular purpose – are limited to two years. Some states do not allow limitations on how long an implied warranty lasts, so the above limitation may not apply to you. This warranty gives you specific legal rights, and you may also have other rights which vary from state to state.

To exercise your rights under this warranty, contact your local authorized Respironics, Inc. dealer or contact Respironics, Inc. at:

1001 Murry Ridge Lane
Murrysville, Pennsylvania 15668-8550
1-724-387-4000



1001 Murry Ridge Lane
Murrysville, PA 15668
USA

Respironics Deutschland
Gewerbestr. 17
82211 Herrsching, Germany



1040200
JR 3/1/07